

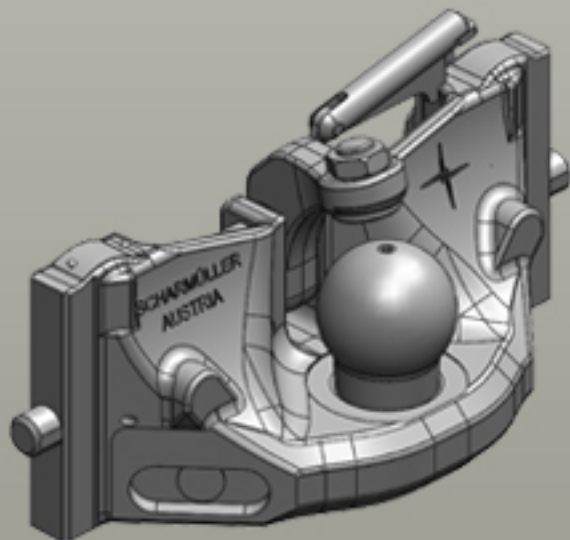









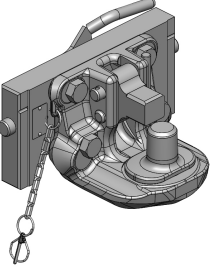

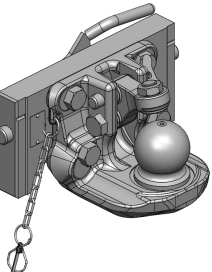
Inserts for Ladder Hitches

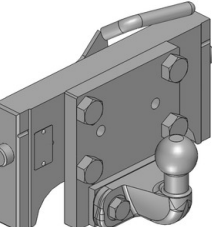
Assembly Dimension Orlandi/Grassi (320/25/38)

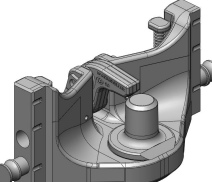

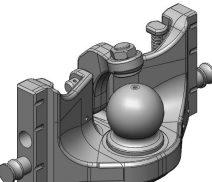
Inserts for Ladder Hitches

	<p>Art.Nr. 03.6320.21-A02 Inserts for Ladder Hitches Coupling Inserts Draw-Pin (Pitonfix) Assembly Dimension Orlandi/Grassi (320/25/38)</p> <p>Alternative color </p> <p>03.6320.21-A02 (Black)</p> <p>Technical Values*</p> <p>Thread: M20 Working Length (mm): 150 Adapter Plate Height (mm): 160 Locking: Draw Pin (Pitonfix) Manual Max. Permissible D-Value (kN): 83,9 Max. Permissible Vertical Load (kg): 2000 • Height Adjustable with Grabhandle</p>
	<p>Art.Nr. 03.6320.41-A02 Inserts for Ladder Hitches Coupling Inserts K80® Ball Coupling System Assembly Dimension Orlandi/Grassi (320/25/38)</p> <p>Alternative color </p> <p>03.6320.41-A02 (Black)</p> <p>Technical Values*</p> <p>Thread: M20 Working Length (mm): 150 Adapter Plate Height (mm): 160 Locking: K80® Manual Max. Permissible D-Value (kN): 83,9 Max. Permissible Vertical Load (kg): 2000 • Height Adjustable with Grabhandle</p>
	<p>Art.Nr. 03.7320.05-A02 Inserts for Ladder Hitches Coupling Inserts ISO 50 (Car) Assembly Dimension Orlandi/Grassi (320/25/38)</p> <p>Alternative color </p> <p>03.7320.05-A02 (Black)</p> <p>Technical Values*</p> <p>Thread: M20 Working Length (mm): 120 Adapter Plate Height (mm): 160 Max. Permissible D-Value (kN): 17 Max. Permissible Vertical Load (kg): 200 • Height Adjustable with Grabhandle</p>
	<p>Art.Nr. 05.6320.16-A02 Inserts for Ladder Hitches Coupling Inserts Draw-Pin (Pitonfix) Assembly Dimension Orlandi/Grassi (320/25/38)</p> <p>Alternative color </p> <p>05.6320.16-A02 (Black)</p> <p>Technical Values*</p> <p>Working Length (mm): 67 Adapter Plate Height (mm): 160 Locking: Draw Pin (Pitonfix) Manual Max. Permissible D-Value (kN): 89,3 Max. Permissible Vertical Load (kg): 3000 • Pluggable with Bolt</p>
	<p>Art.Nr. 05.6320.51-A02 Inserts for Ladder Hitches Coupling Inserts K80® Ball Coupling System Assembly Dimension Orlandi/Grassi (320/25/38)</p> <p>Alternative color </p> <p>05.6320.51-A02 (Black)</p> <p>Technical Values*</p> <p>Working Length (mm): 57 Adapter Plate Height (mm): 160 Locking: K80® Manual Max. Permissible D-Value (kN): 89,3 Max. Permissible Vertical Load (kg): 4000 • Pluggable with Bolt</p>

Inserts for Ladder Hitches

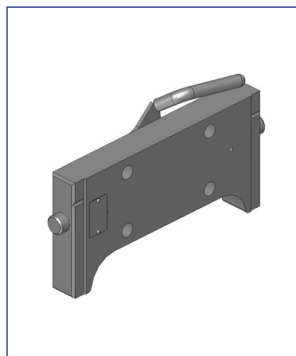

Art.Nr. 03.7320.50-A02 | Inserts for Ladder Hitches | Adapter Plates

Assembly Dimension Orlandi/Grassi (320/25/38)

Alternative color

03.7320.50-A02 (Black)

Technical Values*

Flange Hole Pattern (mm): 140x80 | **Thread:** M20 | **Hole Pattern Holes:** 4 | **Adapter Plate Height (mm):** 160 |
Max. Permissible D-Value (kN): 83,9 | **Max. Permissible Vertical Load (kg):** 2000 | • Height Adjustable with Grabhandle