

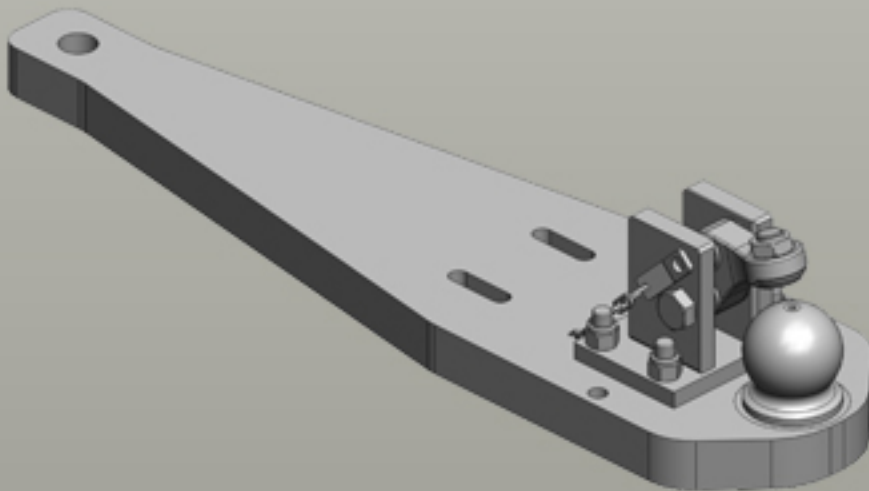

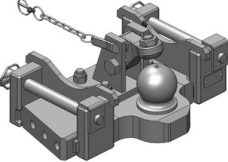







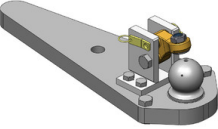

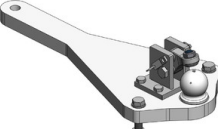

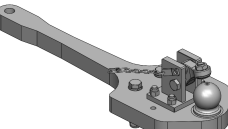
# Heavy Duty Drawbars Fendt

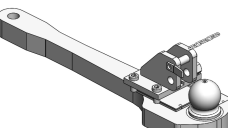

## Heavy Duty Drawbars

	<p><b>Art.Nr. 00.960.306.0-A11   Heavy Duty Drawbars   Standard</b>  K80® Ball Coupling System  </p> <ul style="list-style-type: none"> <li>fits to Original Ladder Hitch (ex factory) with Drawbar Frame</li> </ul> <p><b>Alternative color</b> </p> <p>00.960.306.0-A11 (AGCO-Grey)</p> <p><b>Technical Values*</b></p> <p><b>Lenght (mm):</b> 306   <b>Wide (mm):</b> 443   <b>Assembly-Positions:</b> 1   <b>Thickness (mm):</b> 50   <b>Locking:</b> K80® Manual   <b>Max. Permissible D-Value (kN):</b> 65,7   <b>Max. Permissible Vertical Load (kg):</b> 3000</p> <p><b>Adapted for Tractor</b></p> <p><b>Fendt:</b> <b>Vario 200/300:</b> 207, 208, 209, 210, 211, 309, 310, 311, 312, 313;</p>
	<p><b>Art.Nr. 00.960.310.0-A11   Heavy Duty Drawbars   Standard</b>  K80® Ball Coupling System  </p> <ul style="list-style-type: none"> <li>fits up to 12/2001   fits with Fendt drawbarframe H816.500.120.010</li> </ul> <p><b>Alternative color</b> </p> <p>00.960.310.0-A11 (AGCO-Grey)</p> <p><b>Technical Values*</b></p> <p><b>Lenght (mm):</b> 644   <b>Wide (mm):</b> 234   <b>Assembly-Positions:</b> 1   <b>Thickness (mm):</b> 40   <b>Locking:</b> K80® Manual   <b>Max. Permissible D-Value (kN):</b> 82,4   <b>Max. Permissible Vertical Load (kg):</b> 3000</p> <p><b>Adapted for Tractor</b></p> <p><b>Fendt:</b> <b>Favorit 800:</b> 816, 818, 822, 824; <b>Favorit-Vario 900:</b> 916, 920, 924, 926;</p>
	<p><b>Art.Nr. 00.960.3111.0-A11   Heavy Duty Drawbars   Standard</b>  K80® Ball Coupling System  </p> <ul style="list-style-type: none"> <li>fits with Fendt drawbarframe H385.502.120.012 at LSA-600  </li> <li>fits with Fendt drawbarframe H199.500.120.012 at Farmer 300, Favorit 500C, GTA 300</li> </ul> <p><b>Alternative color</b> </p> <p>00.960.3111.0-A11 (AGCO-Grey)</p> <p><b>Technical Values*</b></p> <p><b>Lenght (mm):</b> 812   <b>Wide (mm):</b> 347   <b>Assembly-Positions:</b> 1   <b>Thickness (mm):</b> 40   <b>Locking:</b> K80® Manual   <b>Max. Permissible D-Value (kN):</b> 65,7   <b>Max. Permissible Vertical Load (kg):</b> 3000</p> <p><b>Adapted for Tractor</b></p> <p><b>Fendt:</b> <b>Farmer 300:</b> 304, 306, 307, 308, 309, 310, 311; <b>Favorit 500C:</b> 509, 510, 511, 512, 514, 515; <b>Favorit 600 LS/LSA/S/SL:</b> 611, 612, 614, 615, 622, 626; <b>GTA 300:</b> 345, 360, 365, 370, 380, 390, 395;</p>
	<p><b>Art.Nr. 00.960.3121.0-A11   Heavy Duty Drawbars   Standard</b>  K80® Ball Coupling System  </p> <ul style="list-style-type: none"> <li>fits to Fendt-Tractors with Year of Construction up to 2008  </li> <li>fits with Fendt drawbarframe H716.501.120.102 for Farmer-Vario 400  </li> <li>fits with Fendt drawbarframe H716.500.120.100 for Favorit-Vario 700, 800</li> </ul> <p><b>Alternative color</b> </p> <p>00.960.3121.0-A11 (AGCO-Grey)</p> <p><b>Technical Values*</b></p> <p><b>Lenght (mm):</b> 885   <b>Wide (mm):</b> 284   <b>Assembly-Positions:</b> 1   <b>Thickness (mm):</b> 50   <b>Locking:</b> K80® Manual   <b>Max. Permissible D-Value (kN):</b> 82,4   <b>Max. Permissible Vertical Load (kg):</b> 3000</p> <p><b>Adapted for Tractor</b></p> <p><b>Challenger:</b> <b>MT 500 Ø TechStar:</b> 525, 535, 545, 555, 565, 575, 585, 595;  <b>Fendt:</b> <b>Farmer-Vario 400:</b> 409, 410, 411, 412; <b>Favorit-Vario 700:</b> 711, 712, 714, 716, 718; <b>Vario 400:</b> 411, 412, 413, 414, 415; <b>Vario 700/800:</b> 711, 712, 714, 716, 718, 815, 816, 817, 818, 820;  <b>Massey Ferguson:</b> <b>6600 Dyna -VT:</b> 6614, 6615, 6616; <b>6700 S Dyna-VT:</b> 6713, 6714, 6715, 6716, 6718; <b>7465-7499:</b> 7465, 7475, 7480, 7485, 7490, 7495, 7497, 7499; <b>7600 Dyna-VT:</b> 7615, 7616, 7618, 7619, 7620, 7622, 7624;</p>
	<p><b>Art.Nr. 00.960.313.0-A11   Heavy Duty Drawbars   Standard</b>  K80® Ball Coupling System  </p> <ul style="list-style-type: none"> <li>fits from 01/2002 up to 12/2007   fits with Fendt drawbarframe H916.501.120.102 for Favorit 800  </li> <li>fits with Fendt drawbarframe H920.500.120.100 for Favorit 900</li> </ul> <p><b>Alternative color</b> </p> <p>00.960.313.0-A11 (AGCO-Grey)</p> <p><b>Technical Values*</b></p> <p><b>Lenght (mm):</b> 757   <b>Wide (mm):</b> 187   <b>Assembly-Positions:</b> 1   <b>Thickness (mm):</b> 50   <b>Locking:</b> K80® Manual   <b>Max. Permissible D-Value (kN):</b> 89,3   <b>Max. Permissible Vertical Load (kg):</b> 3700</p> <p><b>Adapted for Tractor</b></p> <p><b>Fendt:</b> <b>Favorit 800:</b> 816, 818, 822, 824; <b>Favorit-Vario 900:</b> 916, 920, 924, 926; <b>Vario 900:</b> 916, 920, 922, 924, 926, 927, 930, 933, 936;  <b>Massey Ferguson:</b> <b>8400:</b> 8450, 8460, 8470, 8480;</p>

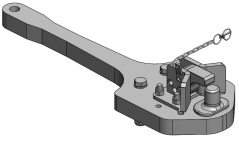
## Heavy Duty Drawbars

	<p><b>Art.Nr. 00.960.3133.0-A11   Heavy Duty Drawbars   Standard</b>  K80® Ball Coupling System  </p> <ul style="list-style-type: none"> <li>fits from 01/2002 up to 12/2007   fits with Fendt drawbarframe H916.501.120.102 for Favorit 800  </li> <li>fits with Fendt drawbarframe H920.500.120.100 for Favorit 900</li> </ul> <p><b>Alternative color</b> </p> <p>00.960.3133.0-A11 (AGCO-Grey)</p> <p><b>Technical Values*</b></p> <p><b>Lenght (mm):</b> 930   <b>Wide (mm):</b> 297   <b>Assembly-Positions:</b> 2   <b>Thickness (mm):</b> 50   <b>Locking:</b> K80® Manual   <b>Max. Permissible D-Value (kN):</b> 89,3   <b>Max. Permissible Vertical Load (kg):</b> 3700</p> <p><b>Adapted for Tractor</b></p> <p><b>Fendt:</b> Favorit <b>800:</b> 816, 818, 822, 824; Favorit-Vario <b>900:</b> 916, 920, 924, 926; Vario <b>900:</b> 916, 920, 922, 924, 926, 927, 930, 933, 936;  <b>Massey Ferguson:</b> <b>8400:</b> 8450, 8460, 8470, 8480;</p>
	<p><b>Art.Nr. 00.960.571.0-A11   Heavy Duty Drawbars   Standard</b>  K80® Ball Coupling System  </p> <ul style="list-style-type: none"> <li>fits to Original Drawbar Frame (ex factory)</li> </ul> <p><b>Alternative color</b> </p> <p>00.960.571.0-A11 (AGCO-Grey)</p> <p><b>Technical Values*</b></p> <p><b>Working Length (mm):</b> 272   <b>Lenght (mm):</b> 1155   <b>Wide (mm):</b> 120   <b>Assembly-Positions:</b> 1   <b>Thickness (mm):</b> 60   <b>Locking:</b> K80® Manual   <b>Max. Permissible D-Value (kN):</b> 120   <b>Max. Permissible Vertical Load (kg):</b> 4000</p> <p><b>Adapted for Tractor</b></p> <p><b>Challenger:</b> <b>MT 700:</b> 738, 740, 743;  <b>Fendt:</b> <b>Vario MT 900:</b> 938, 940, 943;</p>
	<p><b>Art.Nr. 00.961.312.1-A11   Heavy Duty Drawbars   Standard</b>  Draw-Pin (Pitonfix)  </p> <ul style="list-style-type: none"> <li>fits to Fendt-Tractors with Year of Construction up to 2008  </li> <li>fits with Fendt drawbarframe H716.501.120.102 for Farmer-Vario 400  </li> <li>fits with Fendt drawbarframe H716.500.120.100 for Favorit-Vario 700, 800</li> </ul> <p><b>Alternative color</b> </p> <p>00.961.312.1-A11 (AGCO-Grey)</p> <p><b>Technical Values*</b></p> <p><b>Lenght (mm):</b> 885   <b>Wide (mm):</b> 284   <b>Assembly-Positions:</b> 1   <b>Thickness (mm):</b> 50   <b>Locking:</b> Draw Pin (Pitonfix) Manual   <b>Max. Permissible D-Value (kN):</b> 82,4   <b>Max. Permissible Vertical Load (kg):</b> 3000</p> <p><b>Adapted for Tractor</b></p> <p><b>Challenger:</b> <b>MT 500 B TechStar:</b> 525, 535, 545, 555, 565, 575, 585, 595;  <b>Fendt:</b> <b>Farmer-Vario 400:</b> 409, 410, 411, 412; <b>Favorit-Vario 700:</b> 711, 712, 714, 716, 718; <b>Vario 400:</b> 411, 412, 413, 414, 415; <b>Vario 700/800:</b> 711, 712, 714, 716, 718, 815, 816, 817, 818, 820;  <b>Massey Ferguson:</b> <b>7465-7499:</b> 7465, 7475, 7480, 7485, 7490, 7495, 7497, 7499; <b>7600 Dyna-VT:</b> 7615, 7616, 7618, 7619, 7620, 7622, 7624;</p>
	<p><b>Art.Nr. 00.962.573.0-A02   Heavy Duty Drawbars   Standard</b>  K110 Ball Coupling System  </p> <ul style="list-style-type: none"> <li>fits to Version with Controlled-Swing Drawbar Challenger MT-Series</li> </ul> <p><b>Alternative color</b> </p> <p>00.962.573.0-A02 (Black )</p> <p><b>Technical Values*</b></p> <p><b>Lenght (mm):</b> 1530   <b>Wide (mm):</b> 127   <b>Assembly-Positions:</b> 1   <b>Thickness (mm):</b> 60   <b>Locking:</b> K110 Manual   <b>Max. Permissible D-Value (kN):</b> 125   <b>Max. Permissible Vertical Load (kg):</b> 3000</p> <p><b>Adapted for Tractor</b></p> <p><b>Challenger:</b> <b>MT 800:</b> 835, 845, 855, 865, 875; <b>MT 900:</b> 945, 955, 965, 975; <b>MT-C mit 3-Punkt-Hydraulik:</b> 945, 955, 965, 975;  <b>Fendt:</b> <b>Vario MT 1100:</b> 1149, 1154, 1159, 1165;</p>
	<p><b>Art.Nr. 00.964.573.0-A02   Heavy Duty Drawbars   Standard</b>  K80® Ball Coupling System  </p> <ul style="list-style-type: none"> <li>fits to Version with Controlled-Swing Drawbar Challenger MT-Series</li> </ul> <p><b>Alternative color</b> </p> <p>00.964.573.0-A02 (Black )</p> <p><b>Technical Values*</b></p> <p><b>Lenght (mm):</b> 1481   <b>Wide (mm):</b> 127   <b>Assembly-Positions:</b> 1   <b>Thickness (mm):</b> 60   <b>Locking:</b> K80® Manual   <b>Max. Permissible D-Value (kN):</b> 91,3   <b>Max. Permissible Vertical Load (kg):</b> 3000</p> <p><b>Adapted for Tractor</b></p> <p><b>Challenger:</b> <b>MT 800:</b> 835, 845, 855, 865, 875; <b>MT 900:</b> 945, 955, 965, 975; <b>MT-C mit 3-Punkt-Hydraulik:</b> 945, 955, 965, 975;  <b>Fendt:</b> <b>Vario MT 1100:</b> 1149, 1154, 1159, 1165;</p>