

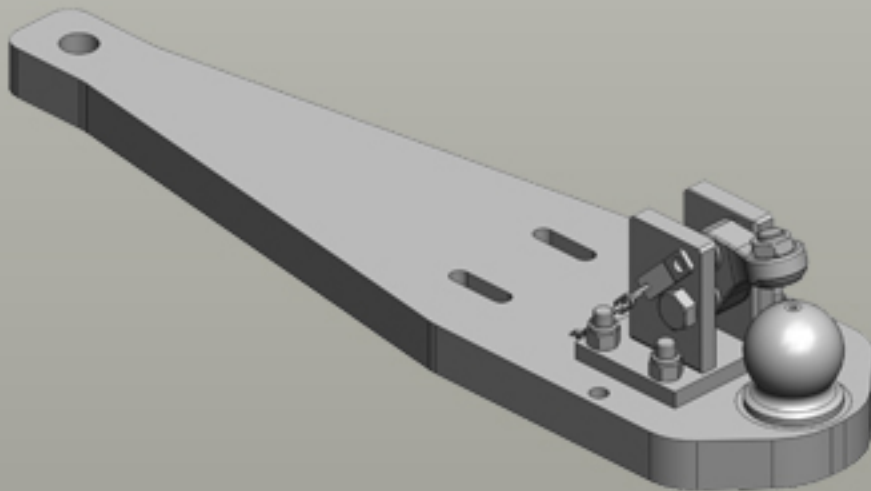







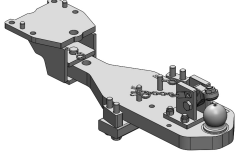

# Heavy Duty Drawbars

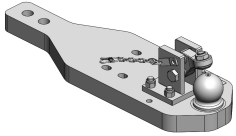
## New Holland | T7 Heavy Duty (Tier 4B)

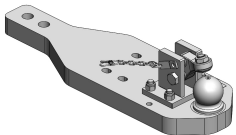

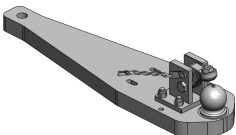
## Heavy Duty Drawbars

	<p><b>Art.Nr. 00.960.521.0-SET-A02   Heavy Duty Drawbars   Standard</b>  K80® Ball Coupling System  </p> <ul style="list-style-type: none"> <li>fits to Sauermann Ladder-Hitch (ex factory) without Drawbar Frame</li> </ul> <p><b>Alternative color</b> </p> <p>00.960.521.0-SET-A02 (Black )</p> <p><b>Technical Values*</b></p> <p><b>Lenght (mm): 768   Wide (mm): 240   Assembly-Positions: 2   Thickness (mm): 50   Locking: K80® Manual   Max. Permissible D-Value (kN): 102,4   Max. Permissible Vertical Load (kg): 4000</b></p> <p><b>Adapted for Tractor</b></p> <p><b>Case IH:</b> Optum CVX (Tier 4B): 250, 270, 300; Optum CVXDrive (Tier 5): 250, 270, 300; Puma CVX EP LWB (Tier 4B): 185, 200, 220, 240; Puma CVXDrive LWB (Tier 5): 185, 200, 220, 240; Puma EP LWB (Tier 4B): 185, 200, 220, 240; Puma Multicontroller LWB (Tier 5): 185, 200, 220;</p> <p><b>New Holland:</b> T7 Heavy Duty (Tier 4B): 7.275, 7.290, 7.315; T7 Heavy Duty (Tier 5): 7.275, 7.290, 7.315; T7 LWB (Tier 4B) : 7.230, 7.245, 7.260, 7.270; T7 LWB (Tier 5): 7.230, 7.245, 7.260, 7.270; T7 SWB (Tier 5): 7.225;</p> <p><b>Steyr:</b> Absolut CVT LWB (Tier 5): 6185, 6200, 6220, 6240; CVT EcoTech LWB (Tier 4B): 6185, 6200, 6220, 6240; Terrus CVT (Tier 4B): 6250, 6270, 6300; Terrus CVT (Tier 5): 6250, 6270, 6300;</p>
	<p><b>Art.Nr. 00.960.522.0-A02   Heavy Duty Drawbars   Standard</b>  K80® Ball Coupling System  </p> <ul style="list-style-type: none"> <li>fits to Scharmüller Ladder-Hitch with Drawbar Frame</li> </ul> <p><b>Alternative color</b> </p> <p>00.960.522.0-A02 (Black )</p> <p><b>Technical Values*</b></p> <p><b>Lenght (mm): 768   Wide (mm): 240   Assembly-Positions: 2   Thickness (mm): 50   Locking: K80® Manual   Max. Permissible D-Value (kN): 102,4   Max. Permissible Vertical Load (kg): 3000</b></p> <p><b>Adapted for Tractor</b></p> <p><b>Case IH:</b> Optum CVX (Tier 4B): 250, 270, 300; Optum CVXDrive (Tier 5): 250, 270, 300; Puma CVX EP LWB (Tier 4A): 170, 185, 200, 215, 230; Puma CVX EP LWB (Tier 4B): 185, 200, 220, 240; Puma CVX LWB: 165, 180, 195, 210, 225; Puma CVXDrive LWB (Tier 5): 185, 200, 220, 240; Puma EP LWB (Tier 4A): 170, 185, 200, 215; Puma EP LWB (Tier 4B): 185, 200, 220; Puma LWB: 165, 180, 195, 210; Puma Multicontroller LWB (Tier 5): 185, 200, 220;</p> <p><b>New Holland:</b> T7 Heavy Duty (Tier 4B): 7.275, 7.290, 7.315; T7 Heavy Duty (Tier 5): 7.275, 7.290, 7.315; T7 LWB (Tier 4A): 7.220, 7.235, 7.250, 7.260, 7.270; T7 LWB (Tier 4B) : 7.230, 7.245, 7.260, 7.270; T7 LWB (Tier 5): 7.230, 7.245, 7.260, 7.270; T7 SWB (Tier 5): 7.225; T7000 Auto Command: 7030, 7040, 7050, 7060, 7070, 7080; T7000 Power Command: 7030, 7040, 7050, 7060;</p> <p><b>Steyr:</b> Absolut CVT LWB (Tier 5): 6185, 6200, 6220, 6240; CVT (Tier 3): 6165, 6180, 6200, 6210, 6225; CVT EcoTech LWB (Tier 4A): 6170, 6185, 6205, 6215, 6230; CVT EcoTech LWB (Tier 4B): 6185, 6200, 6220, 6240; Terrus CVT (Tier 4B): 6250, 6270, 6300; Terrus CVT (Tier 5): 6250, 6270, 6300;</p>
	<p><b>Art.Nr. 00.960.523.0-A02   Heavy Duty Drawbars   Standard</b>  K80® Ball Coupling System  </p> <ul style="list-style-type: none"> <li>fits to Original Drawbar Frame (ex factory)</li> </ul> <p><b>Alternative color</b> </p> <p>00.960.523.0-A02 (Black )</p> <p><b>Technical Values*</b></p> <p><b>Lenght (mm): 877   Wide (mm): 240   Assembly-Positions: 2   Thickness (mm): 50   Locking: K80® Manual   Max. Permissible D-Value (kN): 102,4   Max. Permissible Vertical Load (kg): 3000</b></p> <p><b>Adapted for Tractor</b></p> <p><b>Case IH:</b> Optum CVX (Tier 4B): 250, 270, 300; Optum CVXDrive (Tier 5): 250, 270, 300;</p> <p><b>New Holland:</b> T7 Heavy Duty (Tier 4B): 7.275, 7.290, 7.315; T7 Heavy Duty (Tier 5): 7.275, 7.290, 7.315;</p> <p><b>Steyr:</b> Terrus CVT (Tier 4B): 6250, 6270, 6300; Terrus CVT (Tier 5): 6250, 6270, 6300;</p>
	<p><b>Art.Nr. 00.960.597.4-A02   Heavy Duty Drawbars   Standard</b>  K80® Ball Coupling System  </p> <ul style="list-style-type: none"> <li>fits to Sauermann Ladder-Hitch (ex factory) with Drawbar Frame</li> </ul> <p><b>Alternative color</b> </p> <p>00.960.597.4-A02 (Black )</p> <p><b>Technical Values*</b></p> <p><b>Lenght (mm): 900   Wide (mm): 230   Assembly-Positions: 1   Thickness (mm): 50   Locking: K80® Manual   Max. Permissible D-Value (kN): 89,3   Max. Permissible Vertical Load (kg): 3000</b></p> <p><b>Adapted for Tractor</b></p> <p><b>Case IH:</b> Optum CVX (Tier 4B): 250, 270, 300; Puma CVX EP LWB (Tier 4B): 185, 200, 220, 240;</p> <p><b>New Holland:</b> Puma EP LWB (Tier 4B): 185, 200, 220; T7 Heavy Duty (Tier 4B): 7.275, 7.290, 7.315; T7 LWB (Tier 4B) : 7.1955, 7.2155, 7.230, 7.245, 7.260, 7.270;</p> <p><b>Steyr:</b> CVT EcoTech LWB (Tier 4B): 6185, 6200, 6220, 6240; Terrus CVT (Tier 4B): 6250, 6270, 6300;</p>