

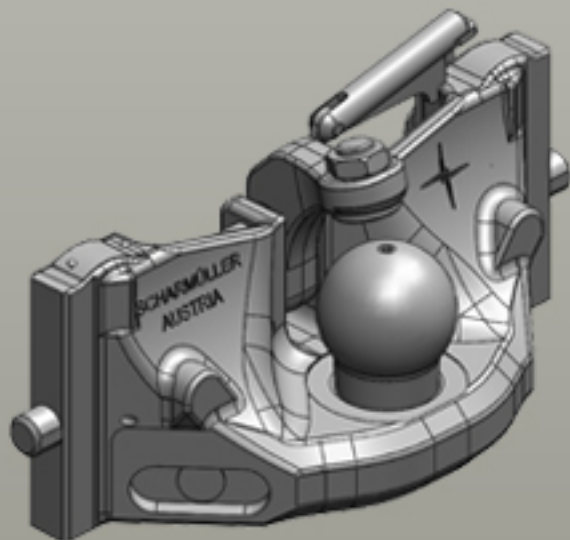





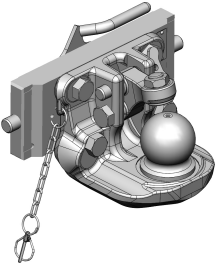

Inserts for Ladder Hitches

Assembly Dimension Archetti (310/22/28)

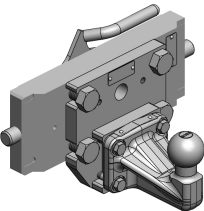

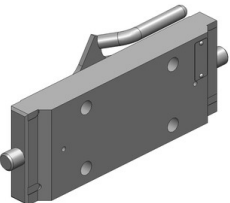
Inserts for Ladder Hitches

	<p>Art.Nr. 03.6310.42-A02 Inserts for Ladder Hitches Coupling Inserts K80® Ball Coupling System Assembly Dimension Archetti (310/22/28)</p> <p>Alternative color </p> <p>03.6310.42-A02 (Black)</p> <p>Technical Values*</p> <p>Thread: M20 Working Length (mm): 155 Adapter Plate Height (mm): 120 Locking: K80® Manual Max. Permissible D-Value (kN): 83,9 Max. Permissible Vertical Load (kg): 2000 • Height Adjustable with Grabhandle</p>
	<p>Art.Nr. 03.7310.03-A02 Inserts for Ladder Hitches Coupling Inserts ISO 50 (Car) Assembly Dimension Archetti (310/22/28)</p> <p>Alternative color </p> <p>03.7310.03-A02 (Black)</p> <p>Technical Values*</p> <p>Thread: M20 Working Length (mm): 168 Adapter Plate Height (mm): 120 Max. Permissible D-Value (kN): 31 Max. Permissible Vertical Load (kg): 250 • Height Adjustable with Grabhandle</p>
	<p>Art.Nr. 03.7310.42-A02 Inserts for Ladder Hitches Adapter Plates Assembly Dimension Archetti (310/22/28)</p> <p>Alternative color </p> <p>03.7310.42-A02 (Black)</p> <p>Technical Values*</p> <p>Flange Hole Pattern (mm): 140x80 Thread: M20 Hole Pattern Holes: 4 Adapter Plate Height (mm): 120 Max. Permissible D-Value (kN): 83,9 Max. Permissible Vertical Load (kg): 2000 • Height Adjustable with Grabhandle</p>