

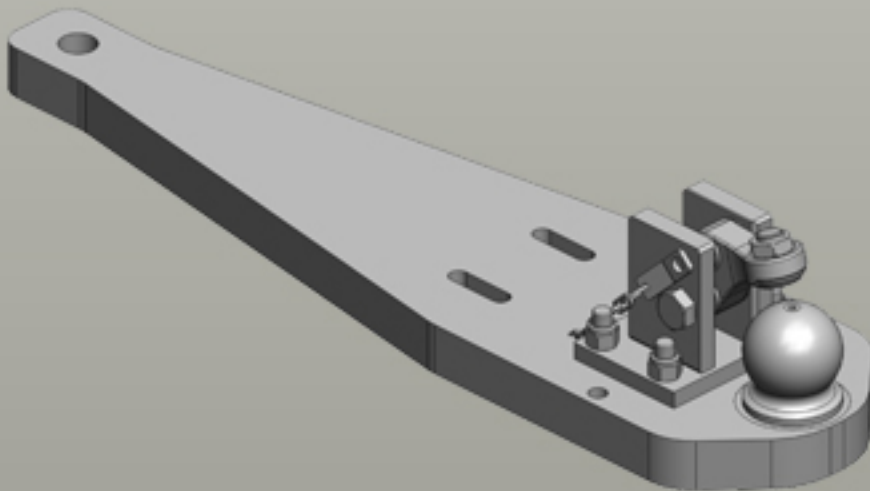







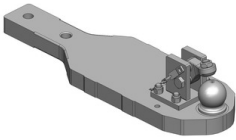

Heavy Duty Drawbars

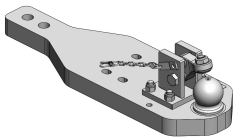
Case IH | Puma CVX EP LWB (Tier 4A)

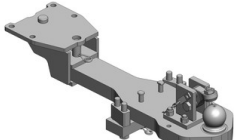

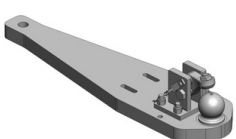
Heavy Duty Drawbars

	<p>Art.Nr. 00.960.290.5-A02 Heavy Duty Drawbars Standard K80® Ball Coupling System </p> <ul style="list-style-type: none"> fits to Scharmüller Ladder-Hitch with Drawbar Frame <p>Alternative color </p> <p>00.960.290.5-A02 (Black)</p> <p>Technical Values*</p> <p>Lenght (mm): 830 Wide (mm): 250 Assembly-Positions: 2 Thickness (mm): 50 Locking: K80® Manual Max. Permissible D-Value (kN): 89,3 Max. Permissible Vertical Load (kg): 4000</p> <p>Adapted for Tractor</p> <p>Case IH: Maxxum MXM: 175, 190; Puma CVX EP LWB (Tier 4A): 170, 185, 200, 215, 230; Puma CVX EP LWB (Tier 4B): 185, 200, 220, 240; Puma CVX LWB: 165, 180, 195, 210, 225; Puma EP LWB (Tier 4A): 170, 185, 200, 215; Puma EP LWB (Tier 4B): 185, 200, 220; Puma LWB: 165, 180, 195, 210; New Holland: T7 LWB (Tier 4A): 7.220, 7.235, 7.250, 7.260, 7.270; T7 LWB (Tier 4B): 7.230, 7.245, 7.260, 7.270; T7000 Auto Command: 7030, 7040, 7050, 7060, 7070, 7080; T7000 Power Command: 7030, 7040, 7050, 7060; TM: 175, 195; Steyr: CVT (Tier 3): 6165, 6180, 6200, 6210, 6225; CVT EcoTech LWB (Tier 4A): 6170, 6185, 6205, 6215, 6230; CVT EcoTech LWB (Tier 4B): 6185, 6200, 6220, 6240;</p>
	<p>Art.Nr. 00.960.522.0-A02 Heavy Duty Drawbars Standard K80® Ball Coupling System </p> <ul style="list-style-type: none"> fits to Scharmüller Ladder-Hitch with Drawbar Frame <p>Alternative color </p> <p>00.960.522.0-A02 (Black)</p> <p>Technical Values*</p> <p>Lenght (mm): 768 Wide (mm): 240 Assembly-Positions: 2 Thickness (mm): 50 Locking: K80® Manual Max. Permissible D-Value (kN): 102,4 Max. Permissible Vertical Load (kg): 3000</p> <p>Adapted for Tractor</p> <p>Case IH: Optum CVX (Tier 4B): 250, 270, 300; Optum CVXDrive (Tier 5): 250, 270, 300; Puma CVX EP LWB (Tier 4A): 170, 185, 200, 215, 230; Puma CVX EP LWB (Tier 4B): 185, 200, 220, 240; Puma CVX LWB: 165, 180, 195, 210, 225; Puma CVXDrive LWB (Tier 5): 185, 200, 220, 240; Puma EP LWB (Tier 4A): 170, 185, 200, 215; Puma EP LWB (Tier 4B): 185, 200, 220; Puma LWB: 165, 180, 195, 210; Puma Multicontroller LWB (Tier 5): 185, 200, 220; New Holland: T7 Heavy Duty (Tier 4B): 7.275, 7.290, 7.315; T7 Heavy Duty (Tier 5): 7.275, 7.290, 7.315; T7 LWB (Tier 4A): 7.220, 7.235, 7.250, 7.260, 7.270; T7 LWB (Tier 4B): 7.230, 7.245, 7.260, 7.270; T7 SWB (Tier 5): 7.225; T7000 Auto Command: 7030, 7040, 7050, 7060, 7070, 7080; T7000 Power Command: 7030, 7040, 7050, 7060; Steyr: Absolut CVT LWB (Tier 5): 6185, 6200, 6220, 6240; CVT (Tier 3): 6165, 6180, 6200, 6210, 6225; CVT EcoTech LWB (Tier 4A): 6170, 6185, 6205, 6215, 6230; CVT EcoTech LWB (Tier 4B): 6185, 6200, 6220, 6240; Terrus CVT (Tier 4B): 6250, 6270, 6300; Terrus CVT (Tier 5): 6250, 6270, 6300;</p>
	<p>Art.Nr. 00.960.594.1-SET3-A02 Heavy Duty Drawbars Standard K80® Ball Coupling System </p> <ul style="list-style-type: none"> fits to Saueremann Ladder-Hitch (ex factory) without Drawbar Frame <p>Alternative color </p> <p>00.960.594.1-SET3-A02 (Black)</p> <p>Technical Values*</p> <p>Lenght (mm): 760 Wide (mm): 240 Assembly-Positions: 2 Thickness (mm): 50 Locking: K80® Manual Max. Permissible D-Value (kN): 86,1 Max. Permissible Vertical Load (kg): 3000</p> <p>Adapted for Tractor</p> <p>Case IH: Puma CVX EP LWB (Tier 4A): 170, 185, 200, 215, 230; Puma EP LWB (Tier 4A): 170, 185, 200, 215; New Holland: T7 LWB (Tier 4A): 7.220, 7.235, 7.250, 7.260, 7.270; Steyr: CVT EcoTech LWB (Tier 4A): 6170, 6185, 6205, 6215, 6230;</p>
	<p>Art.Nr. 00.960.597.2-A02 Heavy Duty Drawbars Standard K80® Ball Coupling System </p> <ul style="list-style-type: none"> fits to Saueremann Ladder-Hitch (ex factory) with Drawbar Frame <p>Alternative color </p> <p>00.960.597.2-A02 (Black)</p> <p>Technical Values*</p> <p>Lenght (mm): 900 Wide (mm): 230 Assembly-Positions: 1 Thickness (mm): 45 Locking: K80® Manual Max. Permissible D-Value (kN): 89,3 Max. Permissible Vertical Load (kg): 3000</p> <p>Adapted for Tractor</p> <p>Case IH: Puma CVX EP LWB (Tier 4A): 170, 185, 200, 215, 230; Puma CVX LWB: 165, 180, 195, 210, 225; Puma EP LWB (Tier 4A): 170, 185, 200, 215; Puma LWB: 165, 180, 195, 210; New Holland: T7 LWB (Tier 4A): 7.220, 7.235, 7.250, 7.260, 7.270; T7000 Auto Command: 7030, 7040, 7050, 7060, 7070, 7080; T7000 Power Command: 7030, 7040, 7050, 7060; Steyr: CVT (Tier 3): 6165, 6180, 6200, 6210, 6225; CVT EcoTech LWB (Tier 4A): 6170, 6185, 6205, 6215, 6230;</p>