

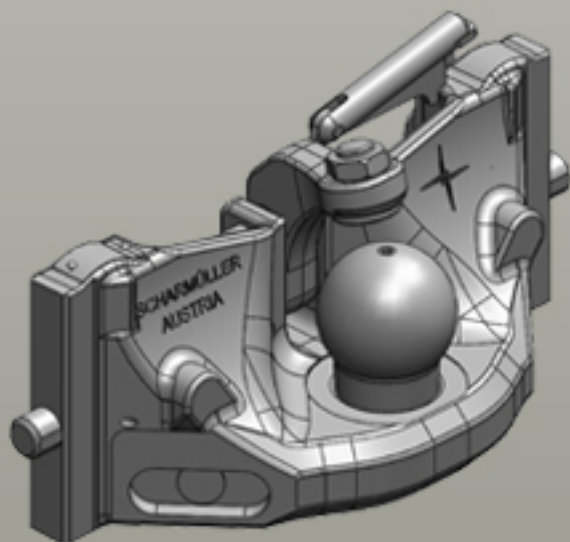

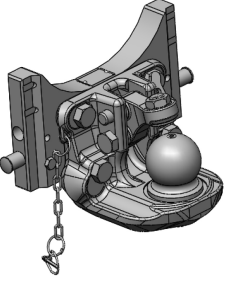







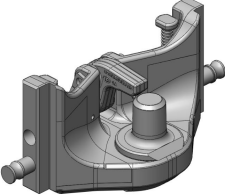

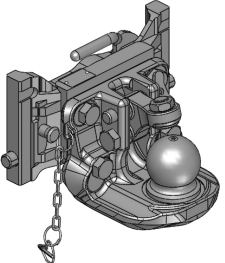

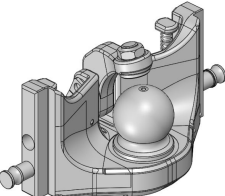

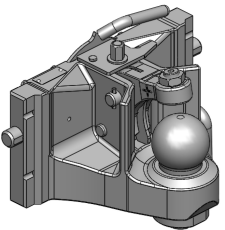



Inserts for Ladder Hitches Assembly Dimension Fendt (311/22/30)

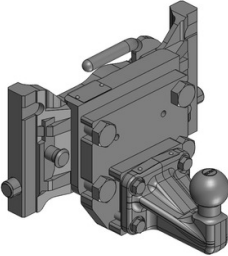

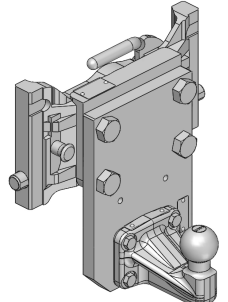
Inserts for Ladder Hitches

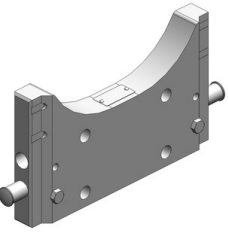
	<p>Art.Nr. 03.6311.44-A02 Inserts for Ladder Hitches Coupling Inserts K80® Ball Coupling System Assembly Dimension Fendt (311/22/30)</p> <p>Alternative color </p> <p>03.6311.44-A02 (Black) 03.6311.44-A11 (AGCO-Grey)</p> <p>Technical Values*</p> <p>Thread: M20 Working Length (mm): 155 Adapter Plate Height (mm): 180 Locking: K80® Manual Max. Permissible D-Value (kN): 83,9 Max. Permissible Vertical Load (kg): 2000 • for Bottom Connection with Wide Angle P.T.O • Pluggable with Bolt</p>
	<p>Art.Nr. 05.6311.16-A11 Inserts for Ladder Hitches Coupling Inserts Draw-Pin (Pitonfix) Assembly Dimension Fendt (311/22/30)</p> <p>Alternative color </p> <p>05.6311.16-A11 (AGCO-Grey)</p> <p>Technical Values*</p> <p>Working Length (mm): 67 Adapter Plate Height (mm): 160 Locking: Draw Pin (Pitonfix) Manual Max. Permissible D-Value (kN): 89,3 Max. Permissible Vertical Load (kg): 3000 • Pluggable with Bolt</p>
	<p>Art.Nr. 05.6311.420-A11 Inserts for Ladder Hitches Coupling Inserts K80® Ball Coupling System Assembly Dimension Fendt (311/22/30)</p> <p>Alternative color </p> <p>05.6311.420-A11 (AGCO-Grey)</p> <p>Technical Values*</p> <p>Thread: M20 Working Length (mm): 177 Adapter Plate Height (mm): 175 Locking: K80® Manual Max. Permissible D-Value (kN): 83,9 Max. Permissible Vertical Load (kg): 2000 • for Top Connection - above the P.T.O Shaft • Height Adjustable with Grabhandle</p>
	<p>Art.Nr. 05.6311.51-A11 Inserts for Ladder Hitches Coupling Inserts K80® Ball Coupling System Assembly Dimension Fendt (311/22/30)</p> <p>Alternative color </p> <p>05.6311.51-A11 (AGCO-Grey)</p> <p>Technical Values*</p> <p>Working Length (mm): 57 Adapter Plate Height (mm): 160 Locking: K80® Manual Max. Permissible D-Value (kN): 89,3 Max. Permissible Vertical Load (kg): 4000 • Pluggable with Bolt</p>
	<p>Art.Nr. 05.6311.61-A11 Inserts for Ladder Hitches Coupling Inserts K80® Ball Coupling System Assembly Dimension Fendt (311/22/30)</p> <p>Alternative color </p> <p>05.6311.61-A11 (AGCO-Grey)</p> <p>Technical Values*</p> <p>Working Length (mm): 152 Adapter Plate Height (mm): 173 Locking: K80® Automatic Max. Permissible D-Value (kN): 89,3 Max. Permissible Vertical Load (kg): 3000 • Remote Control Preparation for other Producers • Height Adjustable with Grabhandle</p>

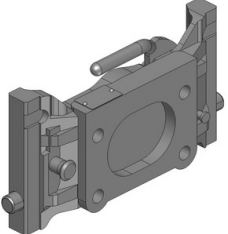
Inserts for Ladder Hitches

	<p>Art.Nr. 05.7311.03-A11 Inserts for Ladder Hitches Coupling Inserts ISO 50 (Car) Assembly Dimension Fendt (311/22/30)</p> <p>Alternative color </p> <p>05.7311.03-A11 (AGCO-Grey)</p> <p>Technical Values*</p> <p>Thread: M20 Working Length (mm): 190 Adapter Plate Height (mm): 175 Max. Permissible D-Value (kN): 31 Max. Permissible Vertical Load (kg): 250 • Height Adjustable with Grabhandle</p>
	<p>Art.Nr. 05.7311.05-A11 Inserts for Ladder Hitches Coupling Inserts ISO 50 (Car) Assembly Dimension Fendt (311/22/30)</p> <p>Alternative color </p> <p>05.7311.05-A11 (AGCO-Grey)</p> <p>Technical Values*</p> <p>Thread: M20 Working Length (mm): 170 Adapter Plate Height (mm): 175 Max. Permissible D-Value (kN): 31 Max. Permissible Vertical Load (kg): 250 • Coupling-Point 10cm lower • Height Adjustable with Grabhandle</p>
	<p>Art.Nr. 03.7311.66-A02 Inserts for Ladder Hitches Adapter Plates Assembly Dimension Fendt (311/22/30)</p> <p>Alternative color </p> <p>03.7311.66-A02 (Black)</p> <p>Technical Values*</p> <p>Flange Hole Pattern (mm): 140x80 Thread: M20 Hole Pattern Holes: 4 Adapter Plate Height (mm): 180 Max. Permissible D-Value (kN): 83,9 Max. Permissible Vertical Load (kg): 2000 • for Bottom Connection with Wide Angle P.T.O • Pluggable with Bolt</p>
	<p>Art.Nr. 05.7311.420-A11 Inserts for Ladder Hitches Adapter Plates Assembly Dimension Fendt (311/22/30)</p> <p>Alternative color </p> <p>05.7311.420-A11 (AGCO-Grey)</p> <p>Technical Values*</p> <p>Flange Hole Pattern (mm): 140x80 Thread: M20 Hole Pattern Holes: 4 Adapter Plate Height (mm): 175 Max. Permissible D-Value (kN): 83,9 Max. Permissible Vertical Load (kg): 2000 • Height Adjustable with Grabhandle</p>