

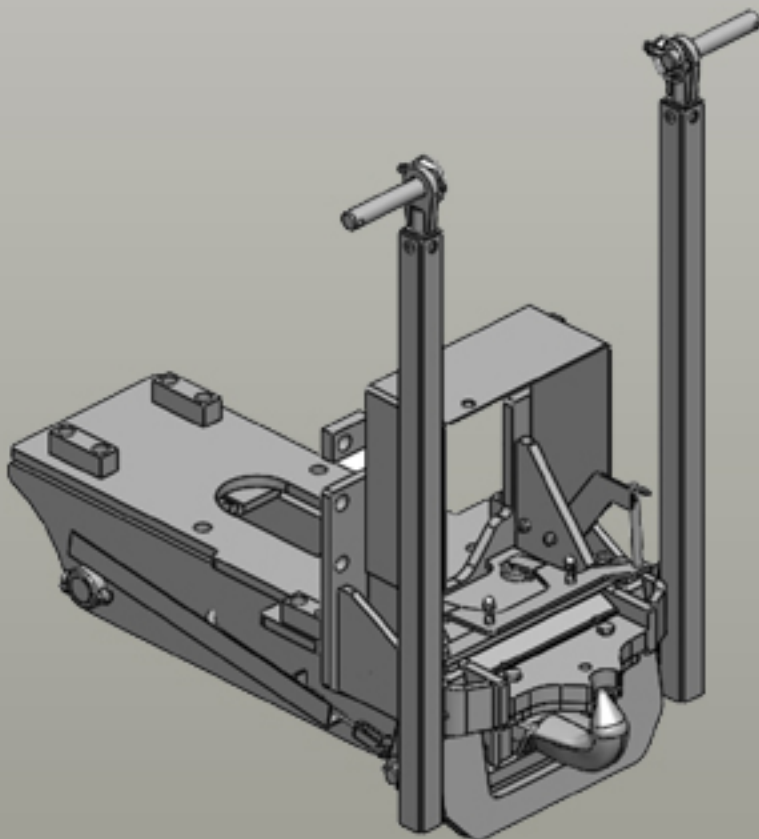





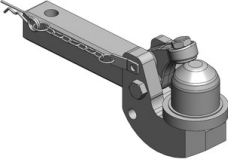

Pick-Up Hitches | Inserts K80®

Case IH

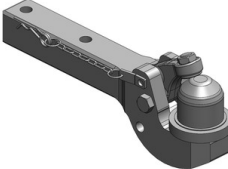

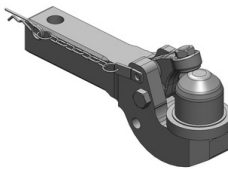
Pick-Up Hitches | Inserts K80®

	<p>Art.Nr. 00.421.12.2-A20 Pick-Up Hitches Inserts K80® K80® Ball Coupling System </p> <p>Alternative color </p> <p>00.421.12.2-A20 (Pöttinger-Red)</p> <p>Technical Values*</p> <p>Working Length (mm): 355 Lenght (mm): 445 Max. Permissible D-Value (kN): 74 Max. Permissible Vertical Load (kg): 1500 Drilled Hole Ø (mm): 25 Shaft Height x Width: 60x60 Pick-Up Hitch Producer: fits with CBM</p> <p>Adapted for Tractor</p> <p>Case IH: Magnum 7100/7200: 7110, 7120, 7130, 7140, 7150, 7210, 7220, 7230, 7240, 7250; Magnum MX: 180, 200, 220, 240, 270; Magnum MX (II): 210, 230, 255, 285, 305; Maxxum MX: 100, 110, 120, 135, 150, 170; Deutz-Fahr: Agrottron 80-180.7: 106, 108, 110, 115, 118, 120, 128, 130, 135, 150, 150.7, 165.7, 180.7; Agrottron TTV: 1130, 1145, 1160, 610, 620; McCormick: MTX: 110, 120, 125, 135, 140, 145, 150, 155; Same: Silver: 105, 110, 130, 95; Zetor: Forterra: 105, 10641, 11441, 115, 11741, 12441, 125, 8621, 8641, 95, 9621, 9641; Proxima: 6421, 6441, 7421, 7441, 8421, 8441;</p>
	<p>Art.Nr. 00.426.11.1-A20 Pick-Up Hitches Inserts K80® K80® Ball Coupling System </p> <p>Alternative color </p> <p>00.426.11.1-A20 (Pöttinger-Red)</p> <p>Technical Values*</p> <p>Working Length (mm): 295 Lenght (mm): 528 Max. Permissible D-Value (kN): 89,3 Max. Permissible Vertical Load (kg): 2000 Hole Pattern/Hole Distance (mm): 153 Drilled Hole Ø (mm): 23 Shaft Height x Width: 70x70 Pick-Up Hitch Producer: fits with Sauermann</p> <p>Adapted for Tractor</p> <p>Case IH: Maxxum MXM: 120, 130, 140, 155, 175, 190; Maxxum MXU: 100, 110, 115, 125, 135; New Holland: TM: 115, 120, 125, 130, 135, 140, 150, 155, 165, 170, 175, 195; TS: 100, 110, 115, 90; TS-A: 100, 110, 115, 125, 135;</p>
	<p>Art.Nr. 00.426.12.1-A20 Pick-Up Hitches Inserts K80® K80® Ball Coupling System </p> <p>Alternative color </p> <p>00.426.12.1-A20 (Pöttinger-Red)</p> <p>Technical Values*</p> <p>Working Length (mm): 355 Lenght (mm): 445 Max. Permissible D-Value (kN): 89,3 Max. Permissible Vertical Load (kg): 2000 Drilled Hole Ø (mm): 30,5 Shaft Height x Width: 70x70 Pick-Up Hitch Producer: fits with CBM</p> <p>Adapted for Tractor</p> <p>Case IH: Magnum MX: 180, 200, 220, 240, 270; Magnum MX (II): 210, 230, 255, 285, 305; Fendt: Vario 700/800: 711, 712, 714, 716, 718, 815, 816, 817, 818, 820; Vario 900: 916, 920, 922, 924, 926, 927, 930, 933, 936; McCormick: TTX: 190, 210, 230; XTX: 185, 200, 215;</p>