

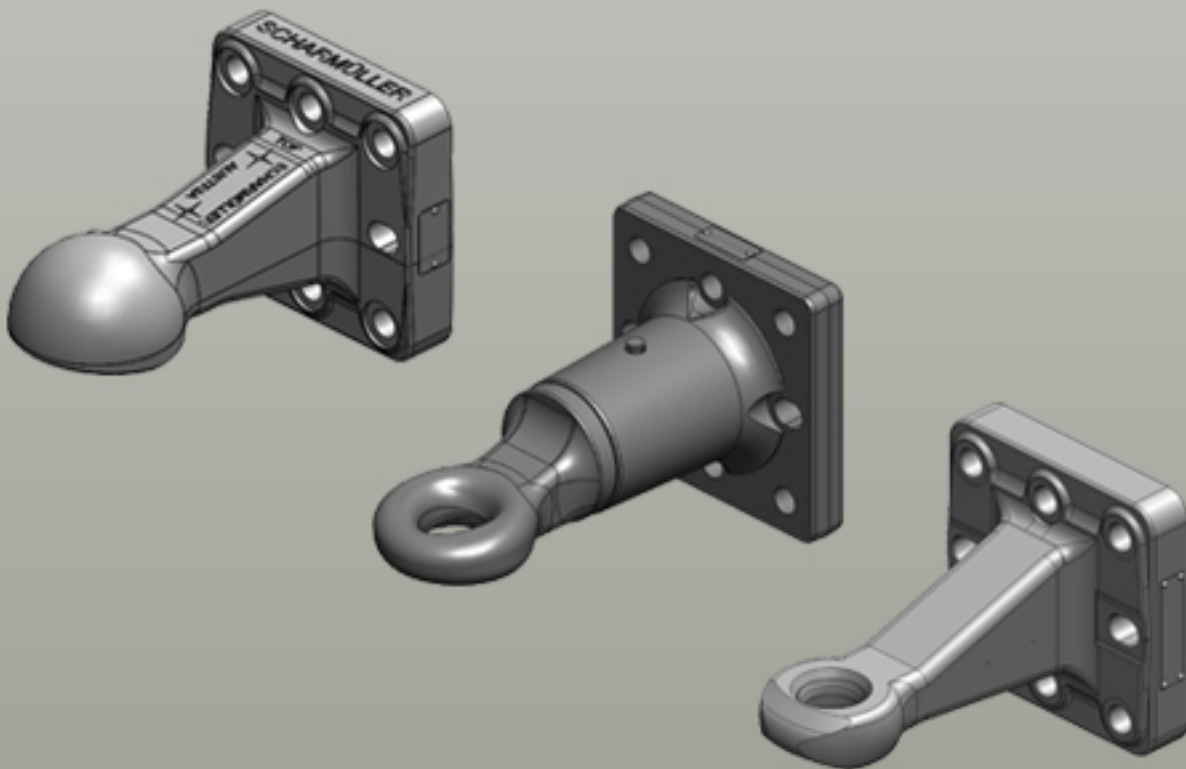

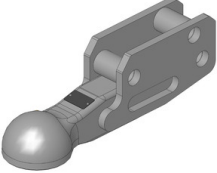







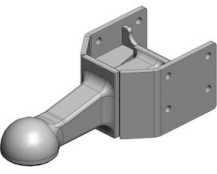

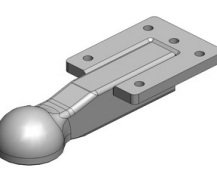
Towing Eyes | Console

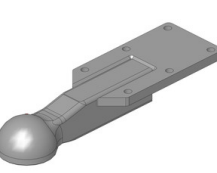

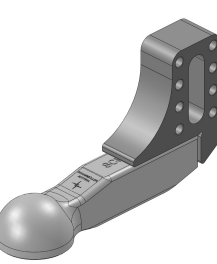
Towing Eyes | Console

	<p>Art.Nr. 00.647.30.0-A02 Towing Eyes Console K80® Towing Eye Ball Coupling System </p> <p>Alternative color </p> <p>00.647.30.0-A02 (Black)</p> <p>Technical Values*</p> <p>Working Length (mm): 195 Lenght (mm): 460 Max. Permissible D-Value (kN): 73,6 Max. Permissible Vertical Load (kg): 2000 • for Top Connection - above the P.T.O Shaft</p> <p>Geeignete Anhänger</p> <p>Krone: Titan: 4, 6, GD, GL; XL: 4, 6; XXL: R/GD;</p>
	<p>Art.Nr. 00.647.375.2-A02 Towing Eyes Console K80® Towing Eye Ball Coupling System </p> <p>Alternative color </p> <p>00.647.375.2-A02 (Black)</p> <p>Technical Values*</p> <p>Flange Hole Pattern (mm): 120x80 Working Length (mm): 305 Lenght (mm): 512 Max. Permissible D-Value (kN): 61,2 Max. Permissible Vertical Load (kg): 2500 Approval Status: ABG General Type Approval</p> <p>Geeignete Anhänger</p> <p>Case IH: LBX: 322, 422, 432; Krone: BiG Pack: 12130, 1270, 1290, 890; New Holland: BB: 920, 930A, 940A, 950A, 960A;</p>
	<p>Art.Nr. 00.648.20.0-A02 Towing Eyes Console K80® Towing Eye Ball Coupling System </p> <p>Alternative color </p> <p>00.648.20.0-A02 (Black)</p> <p>Technical Values*</p> <p>Flange Hole Pattern (mm): 128x150 Working Length (mm): 211 Lenght (mm): 462 Max. Permissible D-Value (kN): 46,6 Max. Permissible Vertical Load (kg): 1500</p>
	<p>Art.Nr. 00.648.25.0-A02 Towing Eyes Console K80® Towing Eye Ball Coupling System </p> <p>Alternative color </p> <p>00.648.25.0-A02 (Black)</p> <p>Technical Values*</p> <p>Flange Hole Pattern (mm): 240x125 Working Length (mm): 231 Lenght (mm): 553 Max. Permissible D-Value (kN): 37,7 Max. Permissible Vertical Load (kg): 1200 Hole Pattern/Hole Distance (mm): 120</p>
	<p>Art.Nr. 00.648.31.0-A02 Towing Eyes Console K80® Towing Eye Ball Coupling System </p> <p>Alternative color </p> <p>00.648.31.0-A02 (Black)</p> <p>Technical Values*</p> <p>Working Length (mm): 288,5 Lenght (mm): 442 Max. Permissible D-Value (kN): 32,1 Max. Permissible Vertical Load (kg): 900</p> <p>Geeignete Anhänger</p> <p>Case IH: RB: 455, 465; New Holland: RB (Roll Belt): 150, 180;</p>