

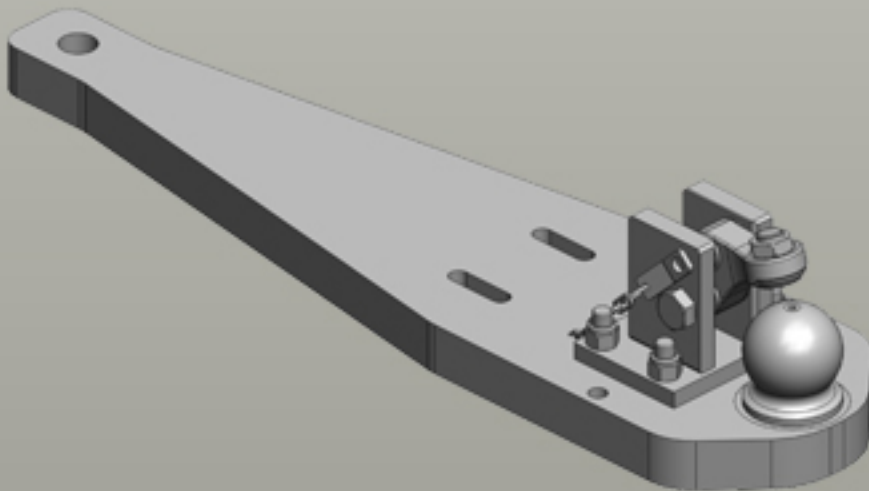

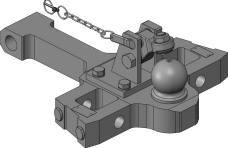







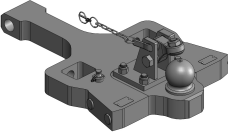

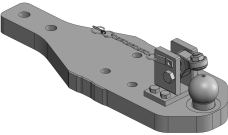

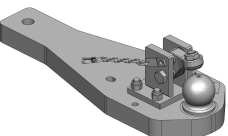

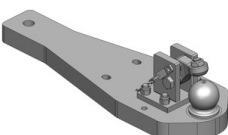
Heavy Duty Drawbars Massey Ferguson | 7700 Dyna-6

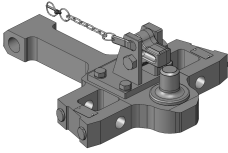

Heavy Duty Drawbars

	<p>Art.Nr. 00.960.321.1-A11 Heavy Duty Drawbars Standard K80® Ball Coupling System </p> <ul style="list-style-type: none"> fits to Original Ladder Hitch (ex factory) with Drawbar Frame <p>Alternative color </p> <p>00.960.321.1-A11 (AGCO-Grey)</p> <p>Technical Values*</p> <p>Lenght (mm): 536 Wide (mm): 455 Assembly-Positions: 1 Thickness (mm): 60 Locking: K80® Manual Max. Permissible D-Value (kN): 97,1 Max. Permissible Vertical Load (kg): 4000</p> <p>Adapted for Tractor</p> <p>Massey Ferguson: 7700 Dyna-6: 7719, 7720, 7722, 7724, 7726;</p>
	<p>Art.Nr. 00.960.322.1-A11 Heavy Duty Drawbars Standard K80® Ball Coupling System </p> <ul style="list-style-type: none"> fits to Original Ladder Hitch (ex factory) with Drawbar Frame <p>Alternative color </p> <p>00.960.322.1-A11 (AGCO-Grey)</p> <p>Technical Values*</p> <p>Working Length (mm): +165 Lenght (mm): 700 Wide (mm): 455 Assembly-Positions: 1 Thickness (mm): 60 Locking: K80® Manual Max. Permissible D-Value (kN): 97,1 Max. Permissible Vertical Load (kg): 3500</p> <p>Adapted for Tractor</p> <p>Massey Ferguson: 7700 Dyna-6: 7719, 7720, 7722, 7724, 7726;</p>
	<p>Art.Nr. 00.960.440.0-A29 Heavy Duty Drawbars Standard K80® Ball Coupling System </p> <ul style="list-style-type: none"> fits to Scharmüller Ladder-Hitch with Drawbar Frame <p>Alternative color </p> <p>00.960.440.0-A29 (Claas-Grey)</p> <p>Technical Values*</p> <p>Working Length (mm): 142 Lenght (mm): 770 Wide (mm): 258 Assembly-Positions: 2 Thickness (mm): 50 Locking: K80® Manual Max. Permissible D-Value (kN): 89,3 Max. Permissible Vertical Load (kg): 4000</p> <p>Adapted for Tractor</p> <p>Claas: Arion 500 (A34/A35): 530, 540, 550; Arion 500 (A74/A75): 510, 530, 540, 550; Arion 500 (A94/A95): 510, 530, 550; Arion 600 (A36/A37): 620, 630, 640, 650; Arion 600 (A76/A77): 610, 620, 630, 640, 650, 660; Arion 600 (A96/A97): 610, 630, 650, 660;</p> <p>Massey Ferguson: 6600 Dyna-6: 6613, 6614, 6615, 6616; 6700 S Dyna-6: 6713, 6714, 6715, 6716, 6718; 7600 Dyna-6: 7615, 7616, 7618; 7700 Dyna-6: 7715, 7716, 7718;</p>
	<p>Art.Nr. 00.960.639.0-A11 Heavy Duty Drawbars Standard K80® Ball Coupling System </p> <ul style="list-style-type: none"> Fits up from Chassis-Number: V285019 at MF 6445-6480 / A1906772 at Claas Arion 500/600 fits to Original Ladder Hitch (ex factory) with Drawbar Frame <p>Alternative color </p> <p>00.960.639.0-A11 (AGCO-Grey)</p> <p>Technical Values*</p> <p>Lenght (mm): 700 Wide (mm): 245 Assembly-Positions: 1 Thickness (mm): 50 Locking: K80® Manual Max. Permissible D-Value (kN): 78,5 Max. Permissible Vertical Load (kg): 3000</p> <p>Adapted for Tractor</p> <p>Claas: Arion 500 (A18): 510, 520, 530, 540; Arion 600 (A19/A20): 610, 620, 630, 640;</p> <p>Massey Ferguson: 6400 Dyna-4/6 / Dynashift: 6445, 6455, 6460, 6465, 6470, 6475, 6480; 6600 Dyna-6: 6613, 6614, 6615, 6616; 6700 S Dyna-6: 6713, 6714, 6715, 6716, 6718; 7600 Dyna-6: 7615, 7616, 7618; 7700 Dyna-6: 7715, 7716, 7718;</p>
	<p>Art.Nr. 00.960.639.1-A11 Heavy Duty Drawbars Standard K80® Ball Coupling System </p> <ul style="list-style-type: none"> Fits up from Chassis-Number: V285019 at MF 6445-6480 / A1906772 at Claas Arion 500/600 fits to Original Pitonfix Ladder Hitch (ex factory) with Drawbar Frame <p>Alternative color </p> <p>00.960.639.1-A11 (AGCO-Grey)</p> <p>Technical Values*</p> <p>Lenght (mm): 738 Wide (mm): 245 Assembly-Positions: 1 Thickness (mm): 50 Locking: K80® Manual Max. Permissible D-Value (kN): 78,5 Max. Permissible Vertical Load (kg): 3000</p> <p>Adapted for Tractor</p> <p>Claas: Arion 500 (A18): 510, 520, 530, 540; Arion 600 (A19/A20): 610;</p> <p>Massey Ferguson: 6400 Dyna-4/6 / Dynashift: 6445, 6455, 6460, 6465, 6470, 6475, 6480; 6600 Dyna-6: 6613, 6614, 6615, 6616; 6700 S Dyna-6: 6713, 6714, 6715, 6716, 6718; 7600 Dyna-6: 7615, 7616, 7618; 7700 Dyna-6: 7715, 7716, 7718;</p>

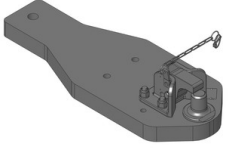
Heavy Duty Drawbars

	<p>Art.Nr. 00.961.321.1-A11 Heavy Duty Drawbars Standard Draw-Pin (Pitonfix) </p> <ul style="list-style-type: none"> fits to Original Ladder Hitch (ex factory) with Drawbar Frame <p>Alternative color </p> <p>00.961.321.1-A11 (AGCO-Grey)</p> <p>Technical Values*</p> <p>Lenght (mm): 536 Wide (mm): 455 Assembly-Positions: 1 Thickness (mm): 60 Locking: Draw Pin (Pitonfix) Manual Max. Permissible D-Value (kN): 97,1 Max. Permissible Vertical Load (kg): 3000</p> <p>Adapted for Tractor</p> <p>Massey Ferguson: 7700 Dyna-6: 7719, 7720, 7722, 7724, 7726;</p>
	<p>Art.Nr. 00.961.639.0-A11 Heavy Duty Drawbars Standard Draw-Pin (Pitonfix) </p> <ul style="list-style-type: none"> Fits up from Chassis-Number: V285019 at MF 6445-6480 / A1906772 at Claas Arion 500/600 fits to Original Ladder Hitch (ex factory) with Drawbar Frame <p>Alternative color </p> <p>00.961.639.0-A11 (AGCO-Grey)</p> <p>Technical Values*</p> <p>Lenght (mm): 700 Wide (mm): 290 Assembly-Positions: 1 Thickness (mm): 50 Locking: Draw Pin (Pitonfix) Manual Max. Permissible D-Value (kN): 78,5 Max. Permissible Vertical Load (kg): 3000</p> <p>Adapted for Tractor</p> <p>Claas: Arion 500 (A18): 510, 520, 530, 540; Arion 600 (A19/A20): 610, 620, 630, 640; Massey Ferguson: 6400 Dyna-4/6 / Dynashift: 6445, 6455, 6460, 6465, 6470, 6475, 6480; 6600 Dyna-6: 6613, 6614, 6615, 6616; 6700 S Dyna-6: 6713, 6714, 6715, 6716, 6718; 7600 Dyna-6: 7615, 7616, 7618; 7700 Dyna-6: 7715, 7716, 7718;</p>