

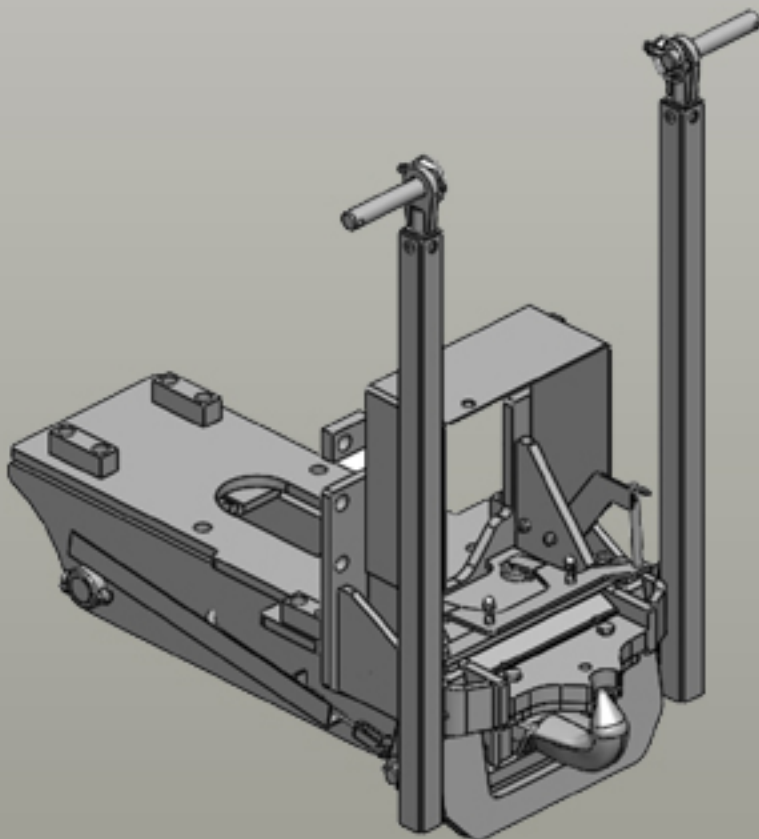

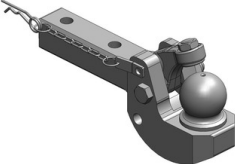







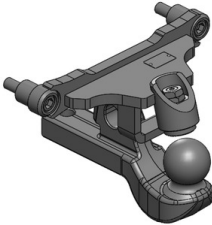

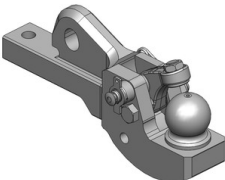
# Pick-Up Hitches | Inserts K80® John Deere

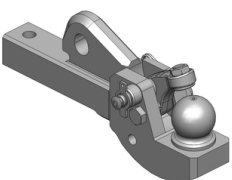

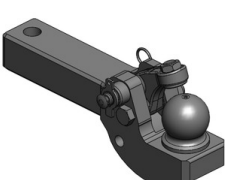
**Pick-Up Hitches | Inserts K80®**

	<p><b>Art.Nr. 00.421.10.2-A20   Pick-Up Hitches   Inserts K80®</b>  K80® Ball Coupling System  </p> <p><b>Alternative color</b> </p> <p>00.421.10.2-A20 (Pöttinger-Red)</p> <p><b>Technical Values*</b></p> <p><b>Working Length (mm):</b> 210   <b>Lenght (mm):</b> 415   <b>Max. Permissible D-Value (kN):</b> 74    <b>Max. Permissible Vertical Load (kg):</b> 1500   <b>Hole Pattern/Hole Distance (mm):</b> 114   <b>Drilled Hole Ø (mm):</b> 22,5    <b>Shaft Height x Width:</b> 60x60   <b>Pick-Up Hitch Producer:</b> fits with Dromone</p> <p><b>Adapted for Tractor</b></p> <p><b>Claas:</b> Ares 500/600: 546, 547, 556, 557, 566, 567, 577, 616, 617, 656, 657, 696, 697; Arion 500 (A18): 510, 520, 530, 540; Arion 600 (A19/A20): 610, 620, 630, 640;  <b>Fendt:</b> Vario 200/300: 207, 208, 209, 210, 211, 309, 310, 311, 312;  <b>John Deere:</b> 7010: 7210, 7410, 7510, 7610, 7710, 7810; 8000: 8100, 8200, 8300, 8400;  <b>Massey Ferguson:</b> 5600 Dyna-4: 5608, 5609, 5610, 5611, 5612, 5613; 5600 Dyna-6: 5608, 5609, 5610, 5611, 5612, 5613; 7600 Dyna-6: 7615, 7616, 7618;</p>
	<p><b>Art.Nr. 00.425.00.4-A17   Pick-Up Hitches   Inserts K80®</b>  K80® Ball Coupling System  </p> <p><b>Alternative color</b> </p> <p>00.425.00.4-A17 (JD-Green)</p> <p><b>Technical Values*</b></p> <p><b>Working Length (mm):</b> 285   <b>Lenght (mm):</b> 354   <b>Max. Permissible D-Value (kN):</b> 78,5    <b>Max. Permissible Vertical Load (kg):</b> 3000   <b>Hole Pattern/Hole Distance (mm):</b> 360   <b>Drilled Hole Ø (mm):</b> 25    <b>Shaft Height x Width:</b> 45x70   <b>Pick-Up Hitch Producer:</b> fits with Sauermann</p> <p><b>Adapted for Tractor</b></p> <p><b>John Deere:</b> 6020: 6820, 6920; 6030: 6830, 6930; 6R 6.170 - 6.210 (Tier 4 Interim): 6.170, 6.190, 6.210; 7020: 7420, 7520; 7030: 7430, 7530;</p>
	<p><b>Art.Nr. 00.428.00.5-A20   Pick-Up Hitches   Inserts K80®</b>  K80® Ball Coupling System  </p> <p><b>Alternative color</b> </p> <p>00.428.00.5-A20 (Pöttinger-Red)</p> <p><b>Technical Values*</b></p> <p><b>Working Length (mm):</b> 390   <b>Lenght (mm):</b> 469   <b>Max. Permissible D-Value (kN):</b> 86,1    <b>Max. Permissible Vertical Load (kg):</b> 3000   <b>Drilled Hole Ø (mm):</b> 25   <b>Shaft Height x Width:</b> 45x70    <b>Pick-Up Hitch Producer:</b> fits with Sauermann</p> <p><b>Adapted for Tractor</b></p> <p><b>John Deere:</b> 6010: 6010, 6110, 6210, 6310, 6410, 6510, 6610, 6810, 6910; 6020: 6020, 6120, 6220, 6320, 6420, 6520, 6620, 6820, 6920; 6030: 6130, 6230, 6330, 6430, 6530, 6534, 6630, 6830, 6930; 6R 6.105 - 6.130 (Tier 4 Interim): 6.105, 6.115, 6.125, 6.130; 6R 6.110 - 6.135 (Tier 4 Final) MY18: 6.110, 6.120, 6.135; 6R 6.140 - 6.150 (Tier 4 Interim): 6.140, 6.150; 6R 6.145 - 6.155 (Tier 4 Final) MY18: 6.145, 6.155; 6R 6.170 - 6.210 (Tier 4 Interim): 6.170, 6.190, 6.210; 7020: 7220, 7320, 7420, 7520, 7720, 7820, 7920; 7030: 7130, 7230, 7330, 7430, 7530, 7730, 7830, 7930; 8010: 8110, 8210, 8310, 8410; 8020: 8120, 8220, 8320, 8420, 8520; 8030: 8130, 8230, 8330, 8430, 8530;</p>
	<p><b>Art.Nr. 00.428.10.0-A20   Pick-Up Hitches   Inserts K80®</b>  K80® Ball Coupling System  </p> <p><b>Alternative color</b> </p> <p>00.428.10.0-A20 (Pöttinger-Red)</p> <p><b>Technical Values*</b></p> <p><b>Working Length (mm):</b> 417   <b>Lenght (mm):</b> 500   <b>Max. Permissible D-Value (kN):</b> 94,1    <b>Max. Permissible Vertical Load (kg):</b> 3000   <b>Drilled Hole Ø (mm):</b> 25   <b>Shaft Height x Width:</b> 60x70    <b>Pick-Up Hitch Producer:</b> fits with Sauermann</p> <p><b>Adapted for Tractor</b></p> <p><b>John Deere:</b> 7R (Tier 3): 7.200, 7.215, 7.230, 7.260, 7.280; 7R (Tier 4 / Stage V): 7R 250, 7R 270, 7R 290, 7R 310, 7R 330, 7R 350; 7R (Tier 4 Interim): 7.210, 7.250, 7.270, 7.290, 7.310;</p>
	<p><b>Art.Nr. 00.429.00.2-A20   Pick-Up Hitches   Inserts K80®</b>  K80® Ball Coupling System  </p> <p><b>Alternative color</b> </p> <p>00.429.00.2-A20 (Pöttinger-Red)</p> <p><b>Technical Values*</b></p> <p><b>Working Length (mm):</b> 360   <b>Lenght (mm):</b> 445   <b>Max. Permissible D-Value (kN):</b> 89,3    <b>Max. Permissible Vertical Load (kg):</b> 2000   <b>Drilled Hole Ø (mm):</b> 30,5   <b>Shaft Height x Width:</b> 70x80    <b>Pick-Up Hitch Producer:</b> fits with Dromone</p> <p><b>Adapted for Tractor</b></p> <p><b>Claas:</b> Axion 800 (A30/A31), Axion 800 (A40/A41), Axion 800 (A60/A61), Axion 900 (A23), Axion 900 (A44)  <b>Fendt:</b> Vario 700/800, Vario 900  <b>John Deere:</b> 8030, 8R (Tier 3A), 8R (Tier 3B)  <b>Massey Ferguson:</b> 6400 Dyna-4 (Tier 2), 6400 Dyna-6 (Tier 3), 7465-7499, 7600 Dyna-6, 7600 Dyna-VT, 8200, 8400, 8600, 8700 Dyna-VT  <b>McCormick:</b> MTX  <b>Valtra:</b> N4-Serie, S2-Serie, S3-Serie, S4-Serie, T4-Serie</p>