

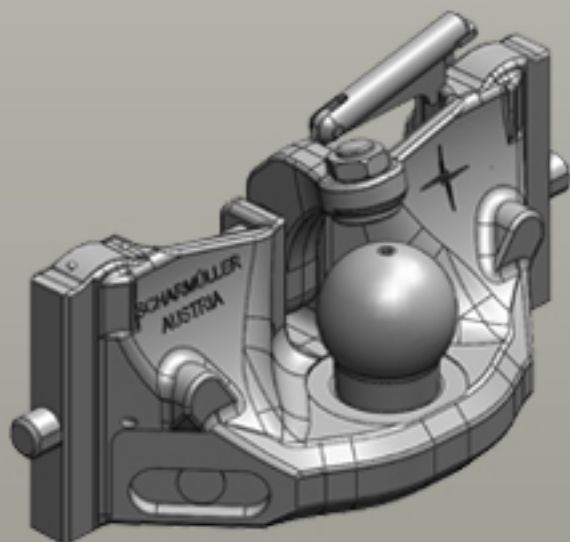

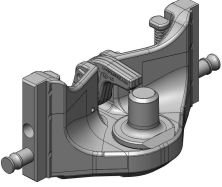







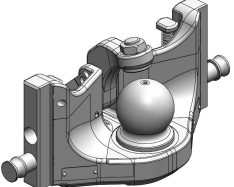

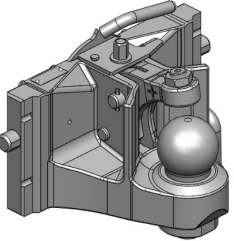

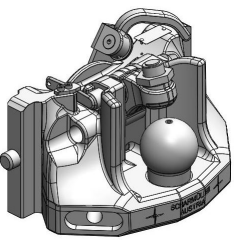

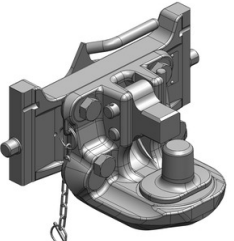



# Inserts for Ladder Hitches Assembly Dimension Cramer (335/22/30)

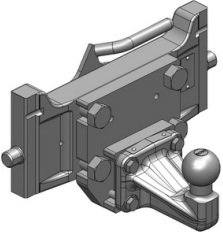

## Inserts for Ladder Hitches

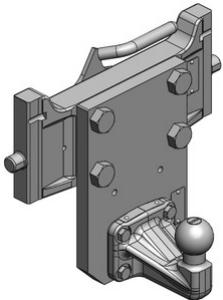
	<p><b>Art.Nr. 05.6335.16-A11   Inserts for Ladder Hitches   Coupling Inserts</b>  Draw-Pin (Pitonfix)   Assembly Dimension Cramer (335/22/30)</p> <p><b>Alternative color</b> </p> <p>05.6335.16-A11 (AGCO-Grey)</p> <p><b>Technical Values*</b></p> <p><b>Working Length (mm):</b> 67   <b>Adapter Plate Height (mm):</b> 160   <b>Locking:</b> Draw Pin (Pitonfix) Manual   <b>Max. Permissible D-Value (kN):</b> 89,3   <b>Max. Permissible Vertical Load (kg):</b> 3000   • Pluggable with Bolt</p>
	<p><b>Art.Nr. 05.6335.51-A11   Inserts for Ladder Hitches   Coupling Inserts</b>  K80® Ball Coupling System   Assembly Dimension Cramer (335/22/30)</p> <p>• Not useable on Claas Arion 600 and MF 6400/7600 with Walterscheid Ladder Hitch</p> <p><b>Alternative color</b> </p> <p>05.6335.51-A11 (AGCO-Grey)</p> <p><b>Technical Values*</b></p> <p><b>Working Length (mm):</b> 57   <b>Adapter Plate Height (mm):</b> 160   <b>Locking:</b> K80® Manual   <b>Max. Permissible D-Value (kN):</b> 89,3   <b>Max. Permissible Vertical Load (kg):</b> 4000   • Pluggable with Bolt</p>
	<p><b>Art.Nr. 05.6335.61-A11   Inserts for Ladder Hitches   Coupling Inserts</b>  K80® Ball Coupling System   Assembly Dimension Cramer (335/22/30)</p> <p><b>Alternative color</b> </p> <p>05.6335.61-A11 (AGCO-Grey)</p> <p><b>Technical Values*</b></p> <p><b>Working Length (mm):</b> 153   <b>Adapter Plate Height (mm):</b> 173   <b>Locking:</b> K80® Automatic   <b>Max. Permissible D-Value (kN):</b> 89,3   <b>Max. Permissible Vertical Load (kg):</b> 3000    • Remote Control Preparation for other Producers   • Height Adjustable with Grabhandle</p>
	<p><b>Art.Nr. 05.6335.70-A11   Inserts for Ladder Hitches   Coupling Inserts</b>  K80® Ball Coupling System   Assembly Dimension Cramer (335/22/30)</p> <p><b>Alternative color</b> </p> <p>05.6335.70-A11 (AGCO-Grey)</p> <p><b>Technical Values*</b></p> <p><b>Working Length (mm):</b> 135   <b>Adapter Plate Height (mm):</b> 160   <b>Locking:</b> K80® Manual   <b>Max. Permissible D-Value (kN):</b> 120,2   <b>Max. Permissible Vertical Load (kg):</b> 4000   • Height Adjustable with Grabhandle</p>
	<p><b>Art.Nr. 07.6335.32-A11   Inserts for Ladder Hitches   Coupling Inserts</b>  Draw-Pin (Pitonfix)   Assembly Dimension Cramer (335/22/30)</p> <p><b>Alternative color</b> </p> <p>07.6335.32-A11 (AGCO-Grey)</p> <p><b>Technical Values*</b></p> <p><b>Thread:</b> M20   <b>Working Length (mm):</b> 155   <b>Adapter Plate Height (mm):</b> 150   <b>Locking:</b> Draw Pin (Pitonfix) Manual   <b>Max. Permissible D-Value (kN):</b> 89,3   <b>Max. Permissible Vertical Load (kg):</b> 3000   • Height Adjustable with Grabhandle</p>

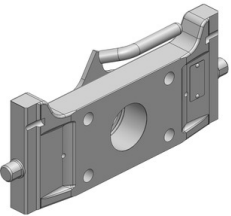
## Inserts for Ladder Hitches

	<p><b>Art.Nr. 07.6335.42-A11   Inserts for Ladder Hitches   Coupling Inserts</b>  K80® Ball Coupling System   Assembly Dimension Cramer (335/22/30)</p> <p><b>Alternative color</b> </p> <p>07.6335.42-A11 (AGCO-Grey)</p> <p><b>Technical Values*</b></p> <p><b>Thread:</b> M20   <b>Working Length (mm):</b> 155   <b>Adapter Plate Height (mm):</b> 150   <b>Locking:</b> K80® Manual    <b>Max. Permissible D-Value (kN):</b> 89,3   <b>Max. Permissible Vertical Load (kg):</b> 3000   • Height Adjustable with Grabhandle</p>
	<p><b>Art.Nr. 07.7335.03-A11   Inserts for Ladder Hitches   Coupling Inserts</b>  ISO 50 (Car)   Assembly Dimension Cramer (335/22/30)</p> <p><b>Alternative color</b> </p> <p>07.7335.03-A11 (AGCO-Grey)</p> <p><b>Technical Values*</b></p> <p><b>Thread:</b> M20   <b>Working Length (mm):</b> 168   <b>Adapter Plate Height (mm):</b> 150   <b>Max. Permissible D-Value (kN):</b> 31    <b>Max. Permissible Vertical Load (kg):</b> 250   • Height Adjustable with Grabhandle</p>
	<p><b>Art.Nr. 07.7335.05-A11   Inserts for Ladder Hitches   Coupling Inserts</b>  ISO 50 (Car)   Assembly Dimension Cramer (335/22/30)</p> <p><b>Alternative color</b> </p> <p>07.7335.05-A11 (AGCO-Grey)</p> <p><b>Technical Values*</b></p> <p><b>Thread:</b> M20   <b>Working Length (mm):</b> 148   <b>Adapter Plate Height (mm):</b> 150   <b>Max. Permissible D-Value (kN):</b> 31    <b>Max. Permissible Vertical Load (kg):</b> 250   • Coupling-Point 10cm lower   • Height Adjustable with Grabhandle</p>
	<p><b>Art.Nr. 07.7335.52-A11   Inserts for Ladder Hitches   Adapter Plates</b>  Assembly Dimension Cramer (335/22/30)</p> <p><b>Alternative color</b> </p> <p>07.7335.52-A11 (AGCO-Grey)</p> <p><b>Technical Values*</b></p> <p><b>Flange Hole Pattern (mm):</b> 140x80   <b>Thread:</b> M20   <b>Hole Pattern Holes:</b> 4   <b>Adapter Plate Height (mm):</b> 150    <b>Max. Permissible D-Value (kN):</b> 89,3   <b>Max. Permissible Vertical Load (kg):</b> 3000   • Height Adjustable with Grabhandle</p>