

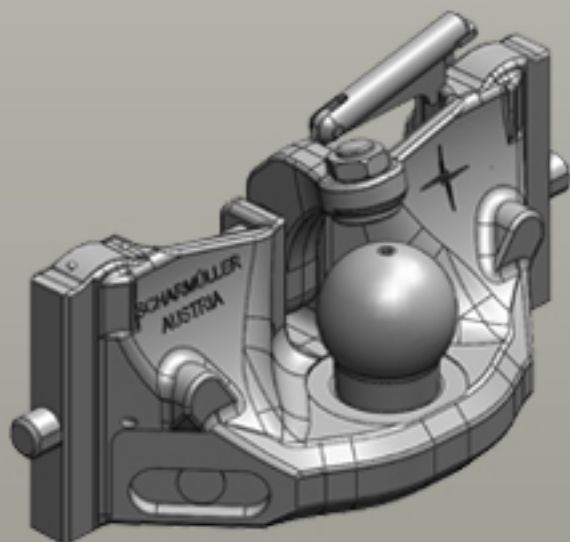

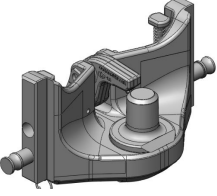







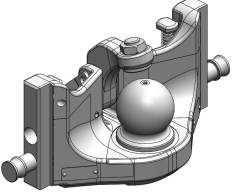

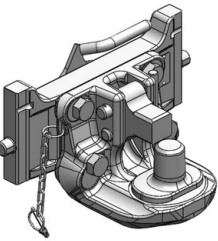
Inserts for Ladder Hitches Assembly Dimension Cramer (309/22/30)

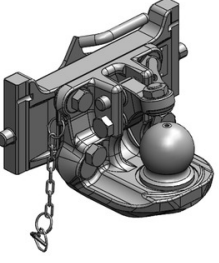

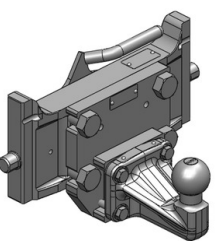
Inserts for Ladder Hitches

	<p>Art.Nr. 05.6309.16-A02 Inserts for Ladder Hitches Coupling Inserts Draw-Pin (Pitonfix) Assembly Dimension Cramer (309/22/30)</p> <p>Alternative color </p> <p>05.6309.16-A02 (Black)</p> <p>Technical Values*</p> <p>Working Length (mm): 67 Adapter Plate Height (mm): 160 Locking: Draw Pin (Pitonfix) Manual Max. Permissible D-Value (kN): 89,3 Max. Permissible Vertical Load (kg): 3000 • Pluggable with Bolt</p>
	<p>Art.Nr. 05.6309.51-A02 Inserts for Ladder Hitches Coupling Inserts K80® Ball Coupling System Assembly Dimension Cramer (309/22/30)</p> <p>Alternative color </p> <p>05.6309.51-A02 (Black)</p> <p>Technical Values*</p> <p>Working Length (mm): 57 Adapter Plate Height (mm): 160 Locking: K80® Manual Max. Permissible D-Value (kN): 89,3 Max. Permissible Vertical Load (kg): 4000 • Pluggable with Bolt</p>
	<p>Art.Nr. 07.6309.32-A02 Inserts for Ladder Hitches Coupling Inserts Draw-Pin (Pitonfix) Assembly Dimension Cramer (309/22/30)</p> <p>Alternative color </p> <p>07.6309.32-A02 (Black)</p> <p>Technical Values*</p> <p>Thread: M20 Working Length (mm): 139 Adapter Plate Height (mm): 150 Locking: Draw Pin (Pitonfix) Manual Max. Permissible D-Value (kN): 89,3 Max. Permissible Vertical Load (kg): 3000 • Height Adjustable with Grabhandle</p>
	<p>Art.Nr. 07.6309.42-A02 Inserts for Ladder Hitches Coupling Inserts K80® Ball Coupling System Assembly Dimension Cramer (309/22/30)</p> <p>Alternative color </p> <p>07.6309.42-A02 (Black)</p> <p>Technical Values*</p> <p>Thread: M20 Working Length (mm): 155 Adapter Plate Height (mm): 150 Locking: K80® Manual Max. Permissible D-Value (kN): 89,3 Max. Permissible Vertical Load (kg): 3000 • Height Adjustable with Grabhandle</p>
	<p>Art.Nr. 07.7309.03-A02 Inserts for Ladder Hitches Coupling Inserts ISO 50 (Car) Assembly Dimension Cramer (309/22/30)</p> <p>Alternative color </p> <p>07.7309.03-A02 (Black)</p> <p>Technical Values*</p> <p>Thread: M20 Working Length (mm): 167 Adapter Plate Height (mm): 150 Max. Permissible D-Value (kN): 31 Max. Permissible Vertical Load (kg): 250 • Height Adjustable with Grabhandle</p>

Inserts for Ladder Hitches

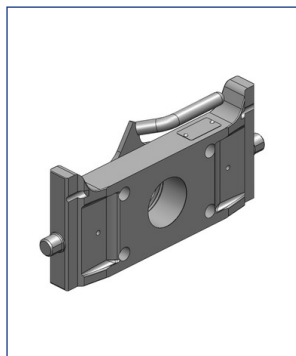

Art.Nr. 07.7309.52-A02 | Inserts for Ladder Hitches | Adapter Plates

Assembly Dimension Cramer (309/22/30)

Alternative color 

07.7309.52-A02 (Black)

Technical Values*

Flange Hole Pattern (mm): 140x80 | **Thread:** M20 | **Hole Pattern Holes:** 4 | **Adapter Plate Height (mm):** 150 |
Max. Permissible D-Value (kN): 89,3 | **Max. Permissible Vertical Load (kg):** 3000 | • Height Adjustable with Grabhandle