

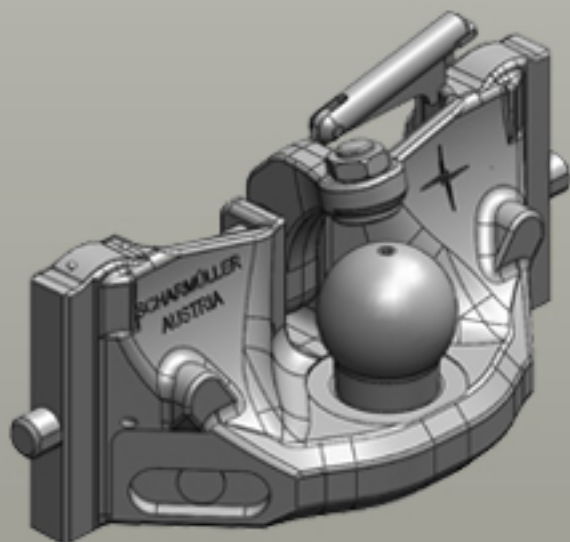









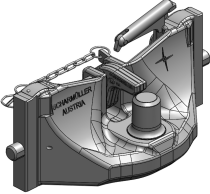

Inserts for Ladder Hitches

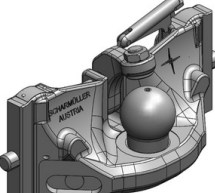
Assembly Dimension Scharmüller S32 (390/25/32)

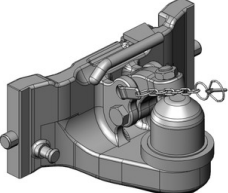

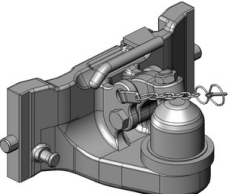

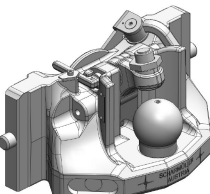





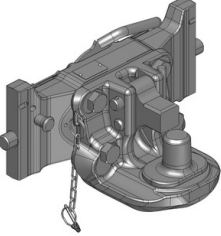

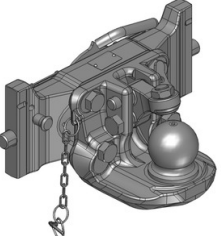
scharmüller 
ANHÄNGERKUPPLUNGEN

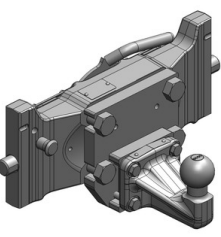
Inserts for Ladder Hitches

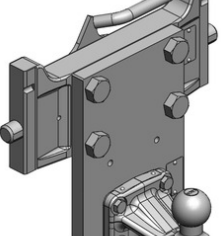
	<p>Art.Nr. 05.6390.16-A02 Inserts for Ladder Hitches Coupling Inserts Draw-Pin (Pitonfix) Assembly Dimension Scharmüller S32 (390/25/32)</p> <p>Alternative color </p> <p>05.6390.16-A02 (Black) 05.6390.16-A17 (JD-Green) 05.6390.16-A11 (AGCO-Grey) 05.6390.16-A34 (Kubota-Grey)</p> <p>Technical Values*</p> <p>Working Length (mm): 80 Adapter Plate Height (mm): 161 Locking: Draw Pin (Pitonfix) Manual Max. Permissible D-Value (kN): 120 Max. Permissible Vertical Load (kg): 3000 • Height Adjustable with Grabhandle</p>
	<p>Art.Nr. 05.6390.46-A02 Inserts for Ladder Hitches Coupling Inserts K80® Ball Coupling System Assembly Dimension Scharmüller S32 (390/25/32)</p> <p>Alternative color </p> <p>05.6390.46-A02 (Black) 05.6390.46-A11 (AGCO-Grey) 05.6390.46-A17 (JD-Green) 05.6390.46-A29 (Claas-Grey)</p> <p>Technical Values*</p> <p>Working Length (mm): 77 Adapter Plate Height (mm): 160 Locking: K80® Manual Max. Permissible D-Value (kN): 120 Max. Permissible Vertical Load (kg): 4000 • Height Adjustable with Grabhandle</p>
	<p>Art.Nr. 05.6390.63-A02 Inserts for Ladder Hitches Coupling Inserts K80® Ball Coupling System Assembly Dimension Scharmüller S32 (390/25/32)</p> <p>Alternative color </p> <p>05.6390.63-A02 (Black) 05.6390.63-A17 (JD-Green) 05.6390.63-A29 (Claas-Grey) 05.6390.63-A34 (Kubota-Grey)</p> <p>Technical Values*</p> <p>Working Length (mm): 170 Adapter Plate Height (mm): 160 Locking: K80® Manual Max. Permissible D-Value (kN): 97,1 Max. Permissible Vertical Load (kg): 3000 • for Top Connection with Wide Angle P.T.O • Height Adjustable with Grabhandle</p>
	<p>Art.Nr. 05.6390.64-A11 Inserts for Ladder Hitches Coupling Inserts K80® Ball Coupling System Assembly Dimension Scharmüller S32 (390/25/32)</p> <p>Alternative color </p> <p>05.6390.64-A11 (AGCO-Grey)</p> <p>Technical Values*</p> <p>Working Length (mm): 170 Adapter Plate Height (mm): 160 Locking: K80® Manual Max. Permissible D-Value (kN): 97,1 Max. Permissible Vertical Load (kg): 3000 • for Top Connection with Wide Angle P.T.O • Height Adjustable with Grabhandle</p>
	<p>Art.Nr. 05.6390.70-A02 Inserts for Ladder Hitches Coupling Inserts K80® Ball Coupling System Assembly Dimension Scharmüller S32 (390/25/32)</p> <p>Alternative color </p> <p>05.6390.70-A02 (Black) 05.6390.70-A17 (JD-Green)</p> <p>Technical Values*</p> <p>Working Length (mm): 135 Adapter Plate Height (mm): 175 Locking: K80® Manual Max. Permissible D-Value (kN): 120,2 Max. Permissible Vertical Load (kg): 4000 • Height Adjustable with Grabhandle</p>

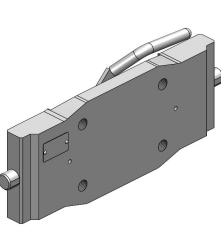
Inserts for Ladder Hitches

	<p>Art.Nr. 07.6390.32-A02 Inserts for Ladder Hitches Coupling Inserts Draw-Pin (Pitonfix) Assembly Dimension Scharmüller S32 (390/25/32)</p> <p>Alternative color </p> <p>07.6390.32-A02 (Black) 07.6390.32-A11 (AGCO-Grey) 07.6390.32-A17 (JD-Green) 07.6390.32-A34 (Kubota-Grey)</p> <p>Technical Values*</p> <p>Thread: M20 Working Length (mm): 166 Adapter Plate Height (mm): 160 Locking: Draw Pin (Pitonfix) Manual Max. Permissible D-Value (kN): 89,3 Max. Permissible Vertical Load (kg): 3000 • Height Adjustable with Grabhandle</p>
	<p>Art.Nr. 07.6390.42-A02 Inserts for Ladder Hitches Coupling Inserts K80® Ball Coupling System Assembly Dimension Scharmüller S32 (390/25/32)</p> <p>Alternative color </p> <p>07.6390.42-A02 (Black) 07.6390.42-A11 (AGCO-Grey) 07.6390.42-A17 (JD-Green) 07.6390.42-A34 (Kubota-Grey)</p> <p>Technical Values*</p> <p>Thread: M20 Working Length (mm): 163 Adapter Plate Height (mm): 160 Locking: K80® Manual Max. Permissible D-Value (kN): 89,3 Max. Permissible Vertical Load (kg): 3000 • Height Adjustable with Grabhandle</p>
	<p>Art.Nr. 07.7390.02-A02 Inserts for Ladder Hitches Coupling Inserts ISO 50 (Car) Assembly Dimension Scharmüller S32 (390/25/32)</p> <p>Alternative color </p> <p>07.7390.02-A02 (Black) 07.7390.02-A11 (AGCO-Grey) 07.7390.02-A17 (JD-Green)</p> <p>Technical Values*</p> <p>Thread: M20 Working Length (mm): 180 Adapter Plate Height (mm): 160 Max. Permissible D-Value (kN): 31 Max. Permissible Vertical Load (kg): 250 • Height Adjustable with Grabhandle</p>
	<p>Art.Nr. 07.7390.05-A02 Inserts for Ladder Hitches Coupling Inserts ISO 50 (Car) Assembly Dimension Scharmüller S32 (390/25/32)</p> <p>Alternative color </p> <p>07.7390.05-A02 (Black)</p> <p>Technical Values*</p> <p>Thread: M20 Working Length (mm): 159 Adapter Plate Height (mm): 160 Max. Permissible D-Value (kN): 31 Max. Permissible Vertical Load (kg): 250 • Coupling-Point 10cm lower • Height Adjustable with Grabhandle</p>
	<p>Art.Nr. 03.7390.60-A02 Inserts for Ladder Hitches Adapter Plates Assembly Dimension Scharmüller S32 (390/25/32)</p> <p>Alternative color </p> <p>03.7390.60-A02 (Black)</p> <p>Technical Values*</p> <p>Flange Hole Pattern (mm): 160x100 Thread: M20 Hole Pattern Holes: 4 Adapter Plate Height (mm): 140 Max. Permissible D-Value (kN): 89,3 Max. Permissible Vertical Load (kg): 2000 • Height Adjustable with Grabhandle</p>

Inserts for Ladder Hitches

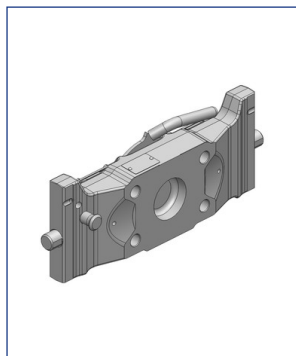

Art.Nr. 07.7390.42-A02 Inserts for Ladder Hitches Adapter Plates	
Assembly Dimension Scharmüller S32 (390/25/32)	
Alternative color	
07.7390.42-A02 (Black) 07.7390.42-A11 (AGCO-Grey) 07.7390.42-A17 (JD-Green) 07.7390.42-A34 (Kubota-Grey)	
Technical Values*	
Flange Hole Pattern (mm): 140x80 Thread: M20 Hole Pattern Holes: 4 Adapter Plate Height (mm): 160 Max. Permissible D-Value (kN): 97,1 Max. Permissible Vertical Load (kg): 3000 • Height Adjustable with Grabhandle	

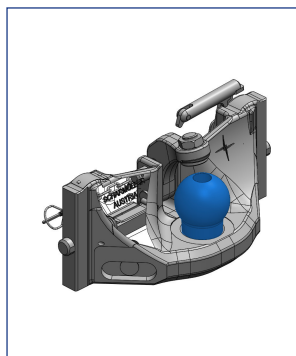

Art.Nr. 85.6390.46-A02 Inserts for Ladder Hitches Lenkkugel K80® EAMS	
K80® Ball Coupling System Assembly Dimension Scharmüller S32 (390/25/32)	
Alternative color	
85.6390.46-A02 (Black)	
Technical Values*	
Working Length (mm): 77 Locking: K80® Manual Max. Permissible D-Value (kN): 120 Max. Permissible Vertical Load (kg): 4000 • Height Adjustable with Grabhandle Measuring Range: Angle Measurement	