

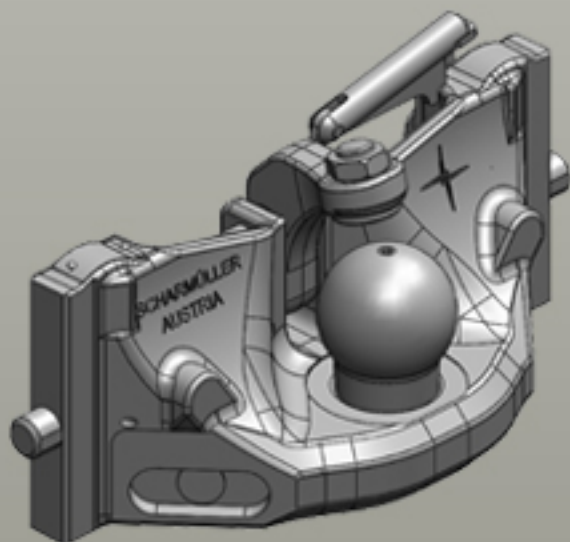









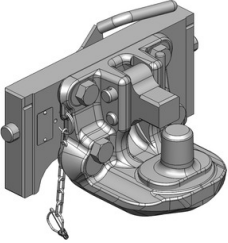

# Inserts for Ladder Hitches

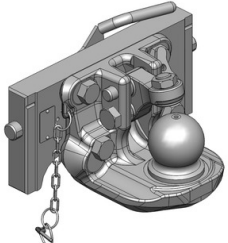
Assembly Dimension Orlandi/Grassi (333/25/38)

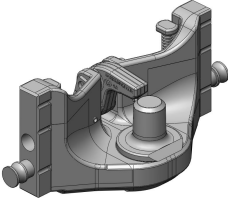

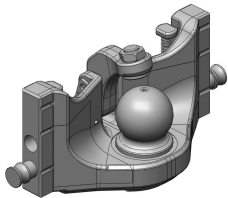
**scharmüller**   
ANHÄNGERKUPPLUNGEN

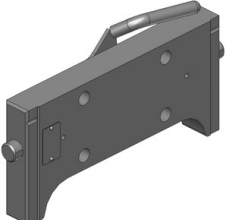
## Inserts for Ladder Hitches

	<p><b>Art.Nr. 03.6334.21-A02   Inserts for Ladder Hitches   Coupling Inserts</b>  Draw-Pin (Pitonfix)   Assembly Dimension Orlandi/Grassi (333/25/38)</p> <p><b>Alternative color</b> </p> <p>03.6334.21-A02 (Black )</p> <p><b>Technical Values*</b></p> <p><b>Thread:</b> M20   <b>Working Length (mm):</b> 150   <b>Adapter Plate Height (mm):</b> 160   <b>Locking:</b> Draw Pin (Pitonfix) Manual   <b>Max. Permissible D-Value (kN):</b> 83,9   <b>Max. Permissible Vertical Load (kg):</b> 2000   • Height Adjustable with Grabhandle</p>
	<p><b>Art.Nr. 03.6334.41-A02   Inserts for Ladder Hitches   Coupling Inserts</b>  K80® Ball Coupling System   Assembly Dimension Orlandi/Grassi (333/25/38)</p> <p><b>Alternative color</b> </p> <p>03.6334.41-A02 (Black )</p> <p><b>Technical Values*</b></p> <p><b>Thread:</b> M20   <b>Working Length (mm):</b> 150   <b>Adapter Plate Height (mm):</b> 160   <b>Locking:</b> K80® Manual   <b>Max. Permissible D-Value (kN):</b> 83,9   <b>Max. Permissible Vertical Load (kg):</b> 2000   • Height Adjustable with Grabhandle</p>
	<p><b>Art.Nr. 05.6334.16-A02   Inserts for Ladder Hitches   Coupling Inserts</b>  Draw-Pin (Pitonfix)   Assembly Dimension Orlandi/Grassi (333/25/38)</p> <p><b>Alternative color</b> </p> <p>05.6334.16-A02 (Black )</p> <p><b>Technical Values*</b></p> <p><b>Working Length (mm):</b> 67   <b>Adapter Plate Height (mm):</b> 160   <b>Locking:</b> Draw Pin (Pitonfix) Manual   <b>Max. Permissible D-Value (kN):</b> 89,3   <b>Max. Permissible Vertical Load (kg):</b> 3000   • Pluggable with Bolt</p>
	<p><b>Art.Nr. 05.6334.51-A02   Inserts for Ladder Hitches   Coupling Inserts</b>  K80® Ball Coupling System   Assembly Dimension Orlandi/Grassi (333/25/38)</p> <p><b>Alternative color</b> </p> <p>05.6334.51-A02 (Black )</p> <p><b>Technical Values*</b></p> <p><b>Working Length (mm):</b> 57   <b>Adapter Plate Height (mm):</b> 160   <b>Locking:</b> K80® Manual   <b>Max. Permissible D-Value (kN):</b> 89,3   <b>Max. Permissible Vertical Load (kg):</b> 4000   • Pluggable with Bolt</p>
	<p><b>Art.Nr. 03.7333.50-A02   Inserts for Ladder Hitches   Adapter Plates</b>  Assembly Dimension Orlandi/Grassi (333/25/38)</p> <p><b>Alternative color</b> </p> <p>03.7333.50-A02 (Black )</p> <p><b>Technical Values*</b></p> <p><b>Flange Hole Pattern (mm):</b> 140x80   <b>Thread:</b> M20   <b>Hole Pattern Holes:</b> 4   <b>Adapter Plate Height (mm):</b> 160   <b>Max. Permissible D-Value (kN):</b> 83,9   <b>Max. Permissible Vertical Load (kg):</b> 2000   • Height Adjustable with Grabhandle</p>